

297002062-CA



THE WORLD IS OUR PLAYGROUND

Nothing is more valuable than your playtime. That is why BRP is dedicated to continually finding new and better ways to help you enjoy your favorite power sports. From snow to water to both on- and off-road fun, our passion for adventure fuels the innovations that result in the ultimate power sports experience for our customers. We value



the land and water we play on and are committed to protecting it. Our desire to thrill is paired with an emphasis on rider responsibility, placing personal safety above all else. So that each outing can be the most enjoyable, memorable and thrilling experience possible. Because your free time should always be your best time.

www.brp.com



SKI-DOO® LYNX® SEA-DOO® EVINRUDE® JOHNSON® ROTAX® CAN-AM®



GENUINE PARTS • ACCESSORIES • RIDING GEAR



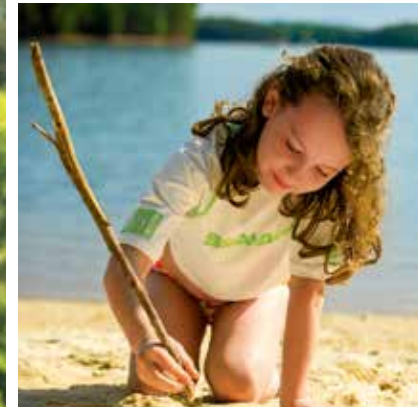

INTRODUCING SEA-DOO SPARK™ LIFESTYLE

For 2014, Sea-Doo is introducing a new PWC, the Sea-Doo Spark, a fun new way for your family to play on the water. This unique PWC experience features a compact and lightweight design that makes it playful to ride and maneuver, simple to own and easy to tow.

Check out our wide range of accessories and customization options, plus our new Rec Lite riding gear collection, made to go perfectly with the Sea-Doo Spark, and our colorful sportswear collection, designed in the same spirit. Now there's nothing holding you back. With the new Sea-Doo Spark matching accessories and riding gear collection, your family's turn to join the fun has arrived.



SHARE your Sea-Doo Spark lifestyle pictures.

#SEADOOSPARKSTYLE



▶ WATCH

the NEW Sea-Doo Spark Collection in action:
store.sea-doo.com/video



THE FUN LASTS LONGER WHEN **SAFETY** IS IN THE DRIVER'S SEAT.

When you're the driver of a personal watercraft, you need to take the safety of your passengers personally.

As the "captain," you are not only responsible for adhering to the safety rules respecting personal watercraft use, but also for ensuring your passengers are wearing the appropriate protective equipment and riding gear.

First of all, you and your passengers are required to wear an approved personal flotation device (PFD) certified for use with a personal watercraft.

Also, a wetsuit and/or neoprene bottoms will provide adequate protection to the lower part of the body. You can suffer severe internal injuries if water is forced into a lower body cavity as a result of falling in the water or being near the jet thrust nozzle. Remember that normal swimwear cannot appropriately protect against forceful water entry.

Finally, extra protective equipment such as footwear, gloves and goggles is also recommended. The fun lasts longer when safety is in the driver's seat.

You can find all of these items at an authorized Sea-Doo dealer or online at store.sea-doo.com.

WE PUT TOGETHER A CREW OF RIDERS LIKE YOU. THEN WE TURNED THEM LOOSE TO PUT OUR **2014** RIDING GEAR AND ACCESSORIES THROUGH THEIR PACES.



MARK QUAVILLON
Melbourne, Florida



KATHY TOMES
Melbourne, Florida



KEVIN WASSUM
Tampa, Florida
Ultimate Sea-Doo Fan and rookie racer



CORRIE WASSUM
Tampa, Florida



KENLEE MCVAY
Easley, South Carolina



ROBERT GAUTHIER
Simpsonville, South Carolina



TOMMY BISHOP-STRAHLO
Melbourne, Florida



ANGIE BISHOP-STRAHLO
Melbourne, Florida



BEN HORAN
Nahunta, Georgia
Pro wakeskater



MILLIE GAUTHIER
Simpsonville, South Carolina



HEATHER TUNING HAMMEN
Oviedo, Florida



JAYDEN HAMMEN
Oviedo, Florida



MATT RITTER
Lake in the hills, Illinois



ASHLEY SPONAUGLER
Tampa, Florida



JOSH ZENTMEYER
Clermont, Florida



DIANE MARIE DOLAN
Boca Raton, Florida



EMMA JORDAN PHILLIPS
Greenville, South Carolina



ROBERT GRESHAM
Atlanta, Georgia



JESSE BURLEW
Satellite Beach, Florida



KALE CARTNER
Charlotte, North Carolina



JEREMY SCHANDELMAYER
Delray Beach, Florida
Professional watercraft racer

2014

RIDING GEAR

PFDs, WETSUITS & RASHGUARDS

- 4 Rec Lite
- 8 Recreation
- 10 Kidswear
- 12 Tow Sports
- 16 Luxury
- 18 Performance
- 22 PFDs Chart

- 23 Sizing Chart
- 24 Technical Gear
- 28 Sportswear

ACCESSORIES

- 34 Accessories
- 37 Attitude Graphic Kits
- 48 Customize your Sea-Doo Spark™
- 49 Build your own Sea-Doo Spark

TRAILERS

- 50 Sea-Doo Move Trailers
- 54 Sea-Doo Move Trailers Accessories

PARTS

- 58 Parts
- 62 XPS Engine Oils & Maintenance Products

LEARN MORE AT A GLANCE

Look for these icons throughout the catalog to learn more about key products:



NEW
New item for 2014.



INNOVATION
An item BRP pioneered that takes your ride to the next level.



DID YOU KNOW
An interesting tidbit about an item beyond the product description.



SPARK LIFESTYLE
Look for the Splash icon throughout the brochure, and locate the Sea-Doo Spark items.

Products in this catalog will be available for purchase at your authorized Sea-Doo dealer and online at store.sea-doo.com in December 2013. For advertising purposes, some scenes depicted in this brochure include professional riders and operators executing under ideal and/or controlled conditions. Do not attempt any of these or any other risky maneuvers if they're beyond your level of riding ability, as well as your understanding and respect for the performance of your Sea-Doo watercraft or boat. RIDE SMART FROM THE START. Always ride responsibly and safely. Follow all instructional and safety materials. BRP recommends a minimum operator age of 16 years old for riding a watercraft. Always wear appropriate protective clothing for your type of boating use, including a Coast Guard approved personal flotation device. Always remember that riding and alcohol/drugs don't mix. Operate your craft keeping a safe distance between yourself and others. Always observe applicable local laws and regulations. Because of its ongoing commitment to product quality and innovation, BRP reserves the right, at any time, to discontinue or change specifications, prices, designs, features, models or equipment without incurring any obligations. Some models depicted herein may include optional equipment. Prices are based on Manufacturer Suggested Retail Prices. Dealers may sell for a different price. Taxes not included. In the U.S.A., products are distributed by BRP US Inc. In Canada, products are distributed by Bombardier Recreational Products Inc. ® are registered trademarks and TM and the BRP Logo are trademarks of Bombardier Recreational Products Inc. or its affiliates. * is a trademark of Bombardier Inc. used under license. Velcro is a registered trademark of Velcro Industries. Clarino is a trademark of Kuraray Co. Ltd. Lycra is a trademark of E.I. DuPont de Nemours & Co. GTX is a registered trademark of Castrol Limited, used under license. 3M is a registered trademark of 3M Canada. NGK is a registered trademark of NGK Spark Plugs, Ltd. YUASA is a registered trademark of YUASA Batteries Inc. All other company and/or product names are trademarks of their respective holders. © 2013 BRP Inc. All rights reserved. Printed in Canada.

SPECIAL FEATURES

- 15 Ben Horan Profile
- 20 James Bushell Profile
- 21 Store.Sea-Doo.com
- 55 Testimonial
- 56 Destination Bound

“July 4th, 9:30 am, water temperature perfect. On the dock with my best friends preparing to slip into our Sea-Doo gear and enjoy one of our favorite days.”

— Tommy Bishop-Strahlo

▶ WATCH the crew wear the NEW Vibe Collection: store.sea-doo.com/video

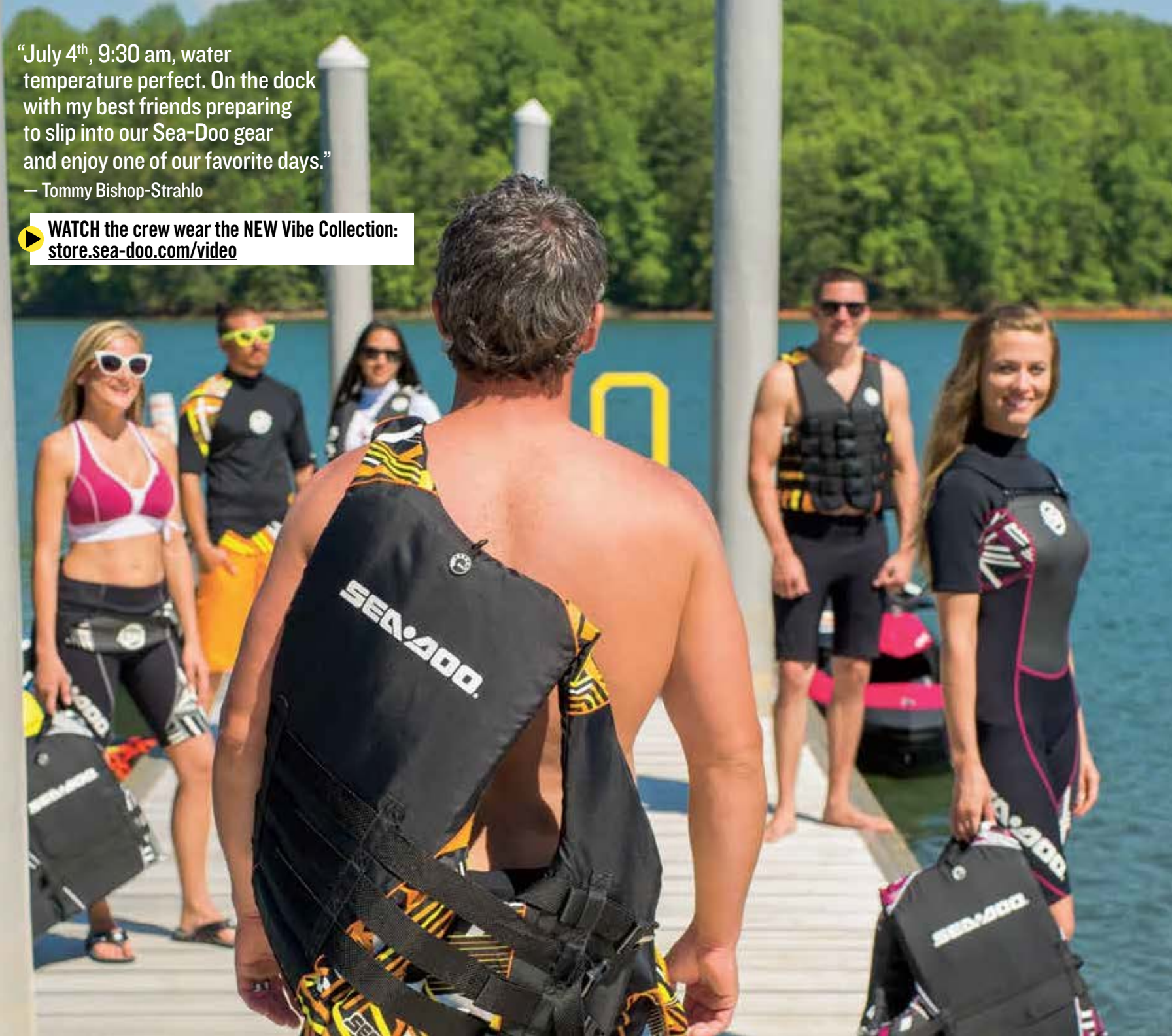

“This suit fits snug and keeps your core warm while allowing you to move freely.”
— Kevin Wassum

✔ The new watercraft-specific Vibe wetsuit features a front entry and zipper that facilitates closing the suit easily, eliminating the hard to reach, rear surf-style zipper cord.

✔ The Sea-Doo Vibe PFD has an integrated D-ring below the center back neckline to attach a goggle lanyard.



MEN'S VIBE PFD
285812 - S, M, L, XL, 2XL - Grey (09), Orange (12)
\$59.99

LADIES' VIBE PFD
285813 - S, M, L, XL, 2XL - Grey (09), Pink (36)
\$59.99



MEN'S VIBE WETSUIT
286422 - S, M, L, XL, 2XL, 3XL - Grey (09), Orange (12)
\$84.99

LADIES' VIBE WETSUIT
286423 - 6, 8, 10, 12, 14 - Grey (09), Pink (36)
\$84.99

N VIBE PFD
Constructed with a super-duty nylon outer shell, polyethylene foam inserts and 4 woven straps with quick release buckles (3 buckles on Canadian Ladies' PFD). Design features include large armholes for unrestricted movement, reinforced seams with vinyl piping, a D-ring for a floating lanyard, plus a D-ring at back neck for goggle-to-PFD attachment cord.

N VIBE WETSUIT
Short wetsuit made of 2 mm neoprene and 4-way stretch fabric underarm, sleeves, lumbar, crotch and collar for more flexibility. Features a waterproof pouch on right leg. Mock turtleneck collar design with horizontal opening zipper. Rubberized front panel for watersport versatility.



"I wear my rashguard on a hot sunny day because protection from the sun is important."
— Corrie Wassum

Sea-Doo rashguards provide sun protection equivalent to SPF 50 UV.

Neoprene shorts can be worn under boardshorts or over bathing suit for an added level of protection.



MEN'S VIBE LS RASHGUARD
286419 - S, M, L, XL, 2XL, 3XL - Grey (09), Orange (12)
\$49.99

MEN'S VIBE SS RASHGUARD
286418 - S, M, L, XL, 2XL, 3XL - Grey (09), Orange (12)
\$34.99



MEN'S NEOPRENE SHORT
Made with 2 mm neoprene, plus an elastic waist with drawstring closure.
286442 - S, M, L, XL, 2XL, 3XL - Black (90)
\$56.99



LADIES' VIBE LS RASHGUARD
286421 - XS, S, M, L, XL, 2XL - Grey (09), Pink (36)
\$49.99

LADIES' VIBE SS RASHGUARD
286420 - XS, S, M, L, XL, 2XL - Grey (09), Pink (36)
\$34.99

LADIES' NEOPRENE SHORT
Made with 2 mm neoprene, reinforced crotch stitching, plus an elastic waist with drawstring closure.
286443 - S, M, L, XL - Black (90)
\$46.99

MEN'S VIBE RASHGUARD
Offers SPF 50 UV protection. Mock turtleneck collar design with boardshort connector. 6 oz. (170 g) Nylon/Spandex.

LADIES' VIBE RASHGUARD
Mock turtleneck collar design with boardshort connector. 6 oz. (170 g) Nylon/Spandex.



“Your riding gear shouldn’t slow you down when getting on the water. Riding gear that’s easy to get into and out of makes the day on the water more fun.”

— Matt Ritter



RECREATION



MEN'S MOTION PFD
285834 • S, M, L, XL, 2XL, 3XL • Red (30), Green (70)
• 4XL • Red (30)

LADIES' MOTION PFD
285837 • XS, S, M, L, XL, 2XL • Red (30), Green (70)
• 3XL, 4XL • Red (30)

\$59.99

\$59.99

MOTION PFD

Super-duty nylon outer shell. Combination of PVC and polyethylene foam inserts. 4 woven straps with quick release buckles (3 buckles on Canadian Ladies' PFD). Reinforced seams with vinyl piping. Armholes cut large for riding comfort. D-ring for lanyard connection and at back neck for goggle-to-PFD attachment cord.

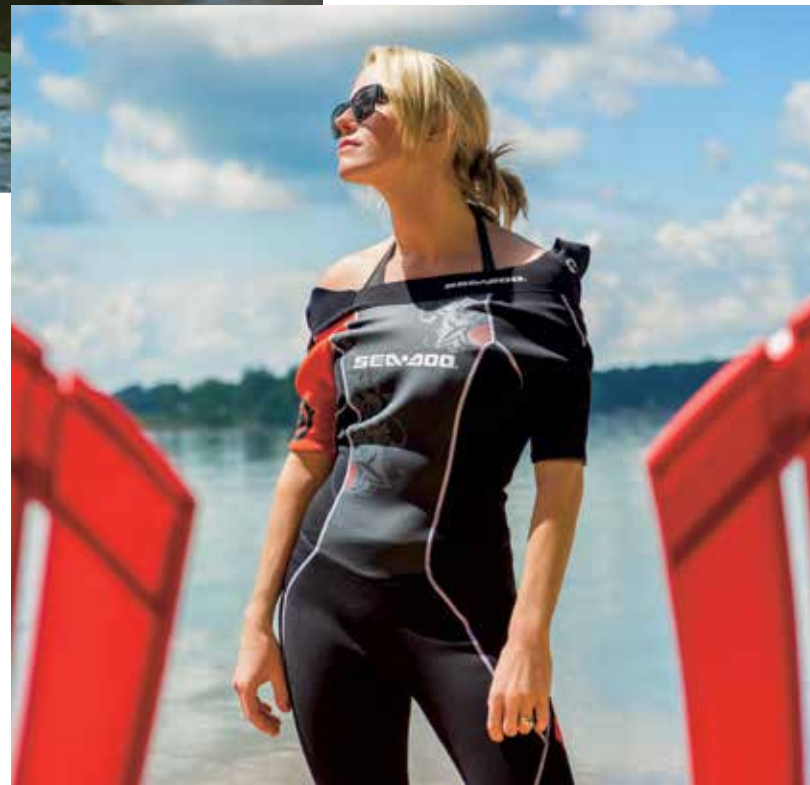

MEN'S SANDSEA SPRINGSUIT
286446 • S, M, L, XL • Red (30), Green (70)
\$74.99

LADIES' SANDSEA SPRINGSUIT
286447 • 6, 8, 10, 12, 14 • Red (30), Green (70)
\$74.99

SANDSEA SPRINGSUIT

Shorty wetsuit designed specifically for watercrafting. Back zip stash pocket on right leg features a waterproof pouch. Constructed of 2 mm neoprene with underarm and lumbar stretch panels for more flexibility, rubberized front panel for grip and watersport versatility. Smoothskin seals at legs, arms and neck, including an adjustable Velcro' collar.



NAVIGATOR PFD

Value-built PFD. Constructed with super-duty nylon outer shell, polyethylene foam inserts and 4 woven straps with quick release buckles, this PFD delivers at an outstanding price. Design details include large armholes, D-ring for lanyard connection and at back neck for goggle-to-PFD attachment cord.

285849 • XS, S/M, L/XL, 2XL/3XL • Hi-Vis Yellow (26), Black (90)
\$44.99



“Kids deserve to have gear specifically made for them. Their fit is different than adults and it’s important that their gear provide the proper safety and protection.”
— Heather Tuning Hammen



JR. FREEWAVE PFD
Ultra-durable neoprene outer shell and lining. Combination of PVC & polyethylene foam inserts. 2 woven straps with quick release buckles. Strategically-placed mesh drain panels. Armholes cut large for comfort. Heavy-duty front zipper. Split tail comfort design. D-ring for your floating lanyard.
285829 • One size (weight 50-90 lb) • Red (30), Green (70)
\$64.99



YOUTH SANDSEA SPRINGSUIT
Shorty wetsuit. Constructed of 2 mm neoprene with underarm and lumbar stretch panels for more flexibility, rubberized front panel for grip and watersport versatility. Smoothskin seals at legs, arms and neck, including an adjustable Velcro collar.
286448 • 8, 10, 12, 14 • Red (30), Green (70)
\$59.99



KIDS' SANDSEA PFD
Built to take the all-day abuse a kid can deliver. Constructed with a super-duty nylon outer shell, polyethylene foam inserts and 3 woven straps with quick release buckles. Armholes are big for comfort.
285840 • S (0-30 lb), M (30-50 lb), L (50-90 lb) • Hi-Vis Yellow (26)
\$32.99



YOUTH RASHGUARD
Lightweight, cool protection for even the hottest days. SPF 50 UV sun protection from the 6 oz. (170 g) Nylon/Spandex materials. Mock turtleneck design.
286440 • 6, 8, 10, 12, 14 • White (01)
\$24.99

“Wakeskating is about self expression, so it’s important that everything you wear is comfortable and moves with you. The more comfortable you are, the more you’ll want to ride.”
— Ben Horan



MEN'S FREEWAVE PFD
285823 • S, M, L, XL, 2XL • Orange (12), Black (90)
• 3XL • Black (90)
\$94.99

LADIES' FREEWAVE PFD
285826 • S, M, L, XL, 2XL • Black (90)
\$94.99

FREEWAVE
Ultra-durable neoprene outer shell and lining. Soft, beveled PVC foam inserts. 2 woven straps with quick release buckles. Strategically-placed mesh drain panels. Armholes cut large for riding comfort. Heavy-duty front zipper. Split tail comfort design. D-ring for lanyard connection and at back neck for goggle-to-PFD attachment cord.





“The gear you wear should be an expression of who and what you are.”
— Ashley Sponaugle

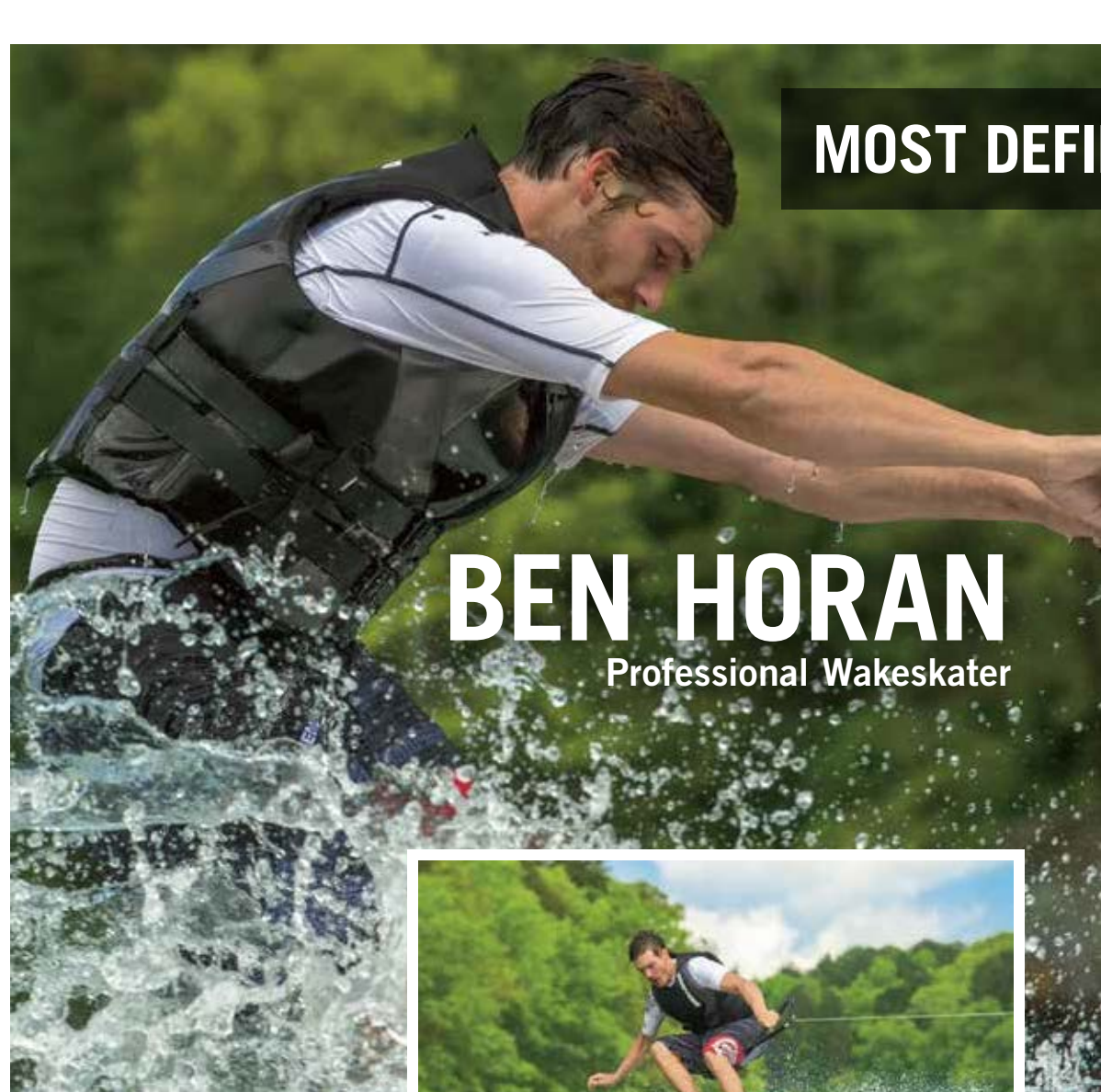

BEN HORAN

Professional Wakeskater

MOST DEFINITELY LIVING THE DREAM

At only 26 years of age, Georgia native Ben Horan is at the top of the wakeskating world.

With countless video parts and contest wins to his credit, as well as a Wakeskater of the Year title and co-ownership of his own brand, Remote Wakeskates, Ben Horan is most definitely living the dream.

And readily admits Sea-Doo helped get him there. An owner long before he became a sponsored rider, a Sea-Doo was actually the very first purchase Horan made with his paychecks from a local skateboard shop. “The pros that I looked up to at the time, guys like Thomas Horrell and Aaron Reed, all used Sea-Dos,” explains Horan. “I wanted to ride like them. That’s honestly why I bought one.”

It was a wise decision. Over the years that followed, that Sea-Doo along with an abundance of natural talent and hard work, helped push Horan to the top of the sport, and earned the respect of both fans and peers.

“Ben is a grounded, humble human being that comes from an incredible family,” says renowned sports photographer Josh Letchworth. “They are supportive of one another, eclectic by nature and go with the flow, all of which make up who Ben is as a person and how he approaches his wakeskating.”

“His commitment to skateboarding most of his life obviously plays a huge role in his riding as well. Ben sees lines and tricks that many can’t visualize. He’s calm, confident, sets

his intention and has been rewarded greatly because of it.”

Though he’s come a long way from that kid at the skate shop, Horan hasn’t wavered in his choice of a Sea-Doo to get the job done. “It’s just super user-friendly,” he says of his preferred WAKE 155. “When I first got into wakeskating my girlfriend was driving me, and then I got my skater friends into it. They’re super easy to drive, and super fun to wakeskate behind. You get a ton of time on the water behind a Sea-Doo. They’re just really awesome.”

Horan also gives high marks to the WAKE’s Ski Mode cruise control (“it’s always the perfect speed”), the advantage of a tow pylon to keep the towrope out of the craft’s jet wash, and Sea-Doo’s renowned Intelligent Brake and Reverse. “When a rider falls, most people do like a hot lap to get back,” says Horan. “That just ruins the water, sending rollers down your line. With the brake you can stop and just turn right around, pick up the rider, and get back to business. It’s so perfect.”

Even the WAKE’s wakes received praise. “It’s a fun little roller to do tricks on. For beginners, that’s the best way to learn board control, just hopping around on the wake and figuring it out.”

“That’s how I learned all my tricks.”

“The pros that I looked up to at the time, guys like Thomas Horrell and Aaron Reed, all used Sea-Dos.”



MEN'S RASHGUARD
Lightweight, cool protection for even the hottest days. SPF 50 UV sun protection from the 6 oz. (170 g) Nylon/Spandex materials. Mock turtleneck collar design also has a boardshort connector.
286438 • S, M, L, XL, 2XL • Green (70), Grey (09)
\$34.99

MEN'S NEOPRENE SHORT
Made with 2 mm neoprene, plus an elastic waist with drawstring closure.
286442 • S, M, L, XL, 2XL, 3XL • Black (90)
\$56.99



LADIES' RASHGUARD
Lightweight, cool protection for even the hottest days. SPF 50 UV sun protection from the 6 oz. (170 g) Nylon/Spandex materials. Mock turtleneck design also has a boardshort connector.
286459 • S, M, L, XL, 2XL • White (01)
\$34.99

LADIES' NEOPRENE SHORT
Made with 2 mm neoprene, reinforced crotch stitching, plus an elastic waist with drawstring closure.
286443 • S, M, L, XL • Black (90)
\$46.99



“When our family goes out for a full day of exploring on the water we want to be comfortable in our riding gear, and of course look good doing it.”

— Robert Gresham

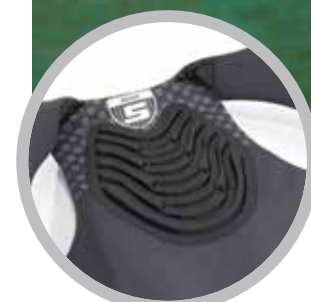

 The neoprene Airflow PFD provides cool weather protection while the EVA inner molding keeps a pocket of air between the vest and the wetsuit for maximum comfort.



LUXURY



MEN'S AIRFLOW PFD
285831 • S, M, L, XL, 2XL • Black (90)
\$124.99



LADIES' AIRFLOW PFD
285854 • S, M, L, XL, 2XL • Black (90)
\$124.99



 **MEN'S DELUXE JACKET**
286458 • S, M, L, XL, 2XL • Black (90)
\$104.99



 **LADIES' DELUXE JACKET**
286445 • XS, S, M, L, XL, 2XL • Black (90)
\$104.99

AIRFLOW PFD

Eco-friendly. Softer, lighter, more durable vest interior constructed of 100% PVC-free Biofoam. Ecoprene outer shell and lining. 2 woven straps with quick release buckles. Heavy-duty front zipper. D-ring for lanyard connection and at back neck for goggle-to-PFD attachment cord.

DELUXE JACKET

Lightweight 1 mm neoprene jacket for use with the Deluxe Wetsuit or separately to take the chill off evening rides and cooler days. Luxury jacket features front zipper. Front pockets with Velcro closures, underarm zipper venting and reflective prints on the shaped sleeves on ladies' jacket.

 **MEN'S DELUXE WETSUIT**
286457 • S, M, L, XL, 2XL • Black (90)
\$149.99

DELUXE WETSUIT

Sleeveless 3/2 mm neoprene wetsuit. Built using stretch neoprene under the arms and side panels, plus articulated back of knees for easy, unrestricted movement. Velcro shoulder closure for easy changing and textured inner knee pads for protection and grip.

 **LADIES' DELUXE WETSUIT**
286444 • 6, 8, 10, 12, 14 • Black (90)
\$149.99



PERFORMANCE

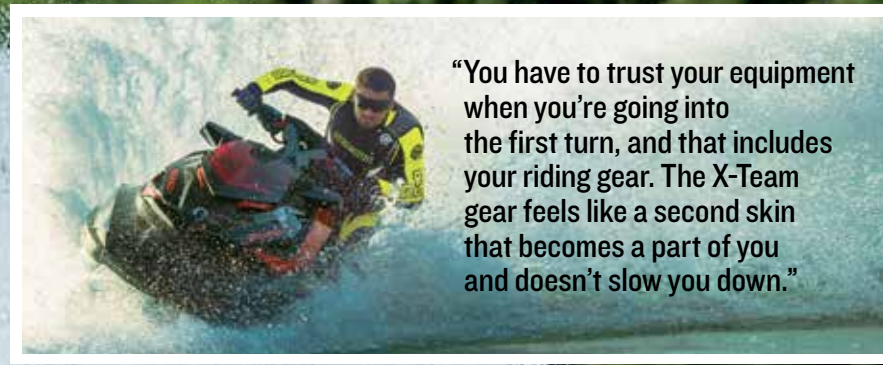

“You have to trust your equipment when you’re going into the first turn, and that includes your riding gear. The X-Team gear feels like a second skin that becomes a part of you and doesn’t slow you down.”



PERFORMANCE

“Everybody has their own style and the X-Team line of gear is designed for the racer who wants to be seen on the water with enough options to build the perfect gear package.”

— Jeremy Schandelmayer

The X-Team neoprene Riding Jacket can be worn over your PFD, providing greater comfort during inclement weather riding.



FORCE PULLOVER PFD
Ultra durable neoprene outer shell and lining with soft PVC foam inserts for maximum comfort. Anatomical cut with large armholes and strategically placed mesh drain panel for riding comfort. Heavy-duty side zipper and two woven straps with quick release buckles for easy ingress/egress. D-ring for lanyard connection and at back neck for goggle-to-PFD attachment cord.
285820 • XS/S, M, L, XL, 2XL/3XL • Yellow (10)
\$124.99



MEN'S X-TEAM SPRINGSUIT
Shorty 2 mm neoprene wetsuit for those in-between weather days. Design features include stretch neoprene panels at the shoulder for easy movement, rubberized front panel for watersport versatility and a smoothskin collar with adjustable Velcro closure for more comfort. Stash your items in the waterproof back pouch or the front leg zipper pocket.
286434 • S, M, L, XL, 2XL • Yellow (10)
\$119.99



MEN'S X-TEAM NEOPRENE RIDING JACKET
Versatile 2 mm neoprene jacket that can be worn over a PFD or independently. Features include articulated inner elbow for easy bending, slit at back waist for comfortable seating, 2-way front zipper, 2 front pockets and a plush lined hood.
286435 • M, L, XL, 2XL • Yellow (10)
\$159.99



MEN'S PERFORMANCE X-TEAM PULLOVER JACKET
High performance X-Team wetsuit pullover for use with or without sleeveless bottom. 3/2 mm neoprene has heavier material where it's needed and lighter where it's not. Features articulated elbows for easy bending and stretch neoprene underarms and side panels to move with your body.
286437 • S, M, L, XL, 2XL • Yellow (10)
\$104.99

MEN'S PERFORMANCE X-TEAM WETSUIT
3/2 mm sleeveless wetsuit with heavier material where it's needed and lighter where it's not. Features include stretch neoprene under arms and articulated knees for easy movement, textured inner knees, back zipper for getting in and out and rubberized front panel for grip and versatility.
286436 • S, M, L, XL, 2XL • Yellow (10)
\$149.99

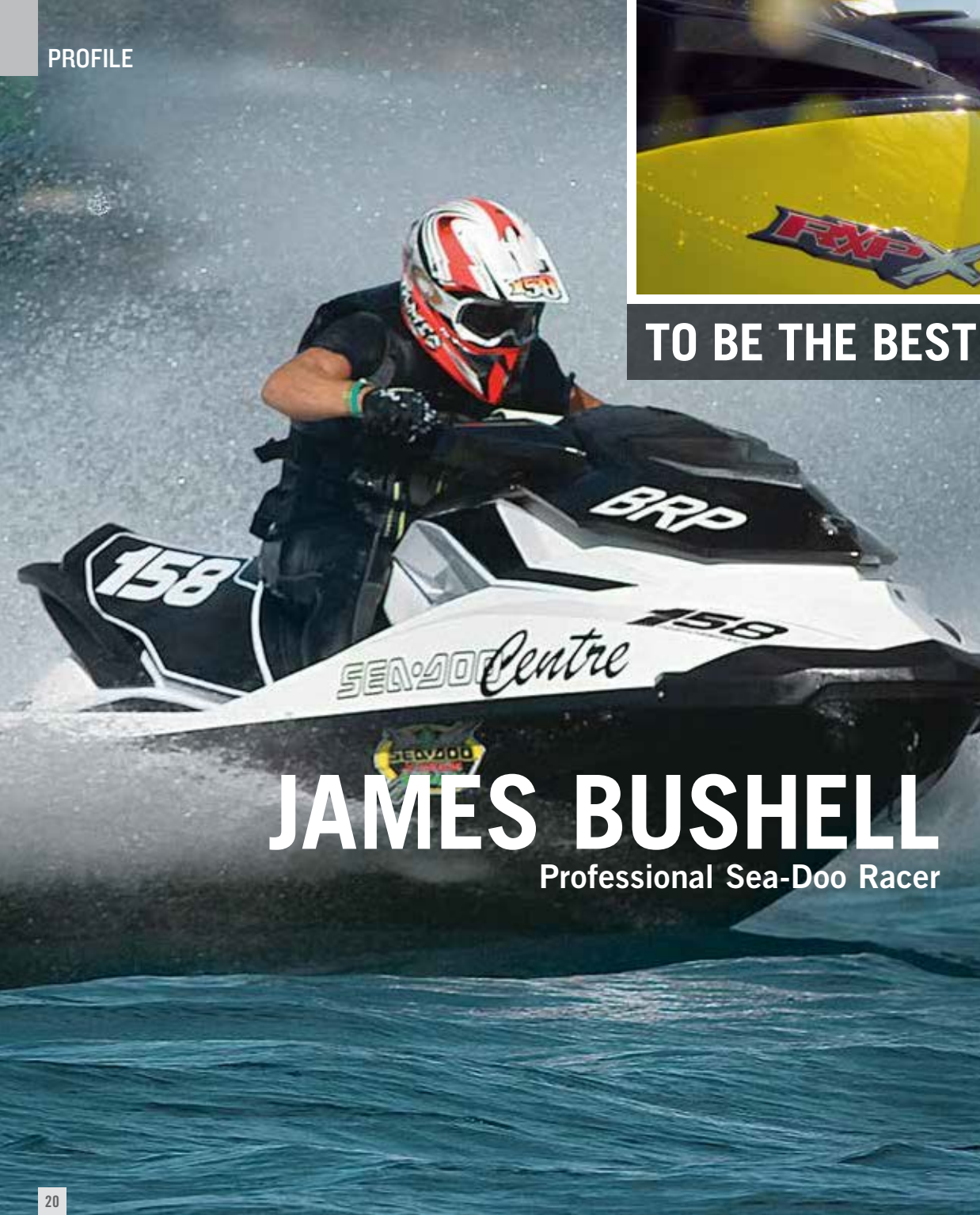

JAMES BUSHELL
Professional Sea-Doo Racer

TO BE THE BEST YOU HAVE TO USE THE BEST



“I just love racing. I love going down the start and grabbing the holeshot. You can’t beat that feeling!”

Q Scores are used to measure the level of an athlete’s popularity at any given moment. In the world of personal watercraft racing, it’s safe to say no one’s Q Score is currently higher than that of Sea-Doo X-Team member James Bushell.

Without question the rider to beat in Pro Runabout contests around the world, this athletic Brit with the model looks has become the new face of Sea-Doo performance by riding his Sea-Doo RXP-X 260 to nine championships worldwide over the past three years. The highlights include a back-to-back, double-double — winning both the 2011 and 2012 IJSBA Pro Open and Pro GP World Championships.

“I love riding the Sea-Doo RXP-X 260”, says Bushell. “The handling is so superior to everything else on the track. I have won my fair share of championships in the past, but now with the RXP-X and the support of Les Cooke (head of Sea-Doo Centre and arguably the most renowned Sea-Doo watercraft racing tuner on the planet), our effort is at a different level. I can go to any race in the world and feel confident we are going to be at the front of the pack. It is really fun times to be racing a Sea-Doo.”

One of the most approachable big-name, professional-watercraft racers

in the paddock area, Bushell radiates a low-key, down-to-earth demeanor that is inviting to fans.

But make no mistake, deep down resides a burning desire to win, and win everything — every single time he is on the water. “I love this sport, I love meeting different people around the world, but obviously the main goal is to win”, he emphasizes. “I just love racing. I love going down the start and grabbing the holeshot at 125 km/h. You can’t beat that feeling!”

Bushell has an added incentive to succeed. He’s the director of his own UK-based BRP dealership, 158-Performance. “It’s pretty cool to have a customer come into the store, or stop by our booth at the London Boat Show, and see a huge poster of me on the wall or in the brochure and ask, ‘Is that you?’ and be able to say ‘yes.’ They see me on the machine, they see me wearing the Sea-Doo Performance X-Team wetsuit, PFD, gloves, booties, everything. It’s cool!”

And certainly does a lot for one’s Q Score.

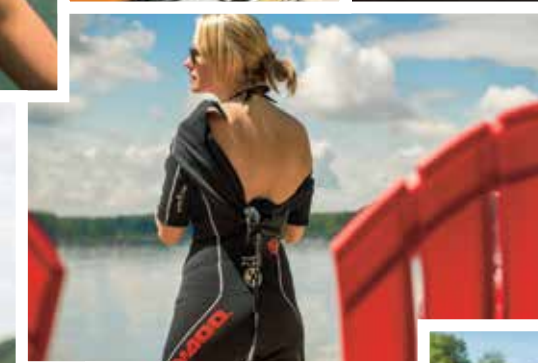

STORE.SEA-DOO.COM



Online store for Parts, Accessories and Riding Gear.



Check out our latest videos including the new Sea-Doo Spark collection in action.



Access the Sea-Doo Attitude Graphic Kits online store.



The 2014 Sea-Doo line-up will be available at your authorized Sea-Doo Dealer and online in December 2013.



Sign up for Sea-Doo eNews and get FREE SHIPPING the next time you buy online. Valid with all orders of \$100 and more.

CHOOSE THE PFD THAT IS RIGHT FOR YOUR RIDING STYLE



VIBE	MOTION	NAVIGATOR	KIDS' SANDSEA	FREEWAVE	JR. FREEWAVE	FORCE	AIRFLOW
REC LITE	RECREATIONAL			TOW SPORTS	RECREATIONAL	PERFORMANCE	LUXURY
Offers dynamic full features in a rugged, durable nylon vest that fits in anywhere, anytime.	Lightweight, excellent wear & flex fatigue resistance, low water absorption. Affordable, dependable all purpose PFD.	Super-duty nylon outer shell. Affordable, dependable all purpose PFD.	Lightweight, low water absorption. Affordable, dependable all purpose PFD.	A more fitted and technical PFD. Offers greater ease of movement, better comfort and more warmth.	Offers greater ease of movement, better comfort and more warmth.	Offers warmth, a better fit, more comfort and greater ease of movement. For riders looking for a more technical and fitted PFD.	Ecoprene: the advantages of neoprene with optimum protection. 30% lighter than standard neoprene PFDs. Dries faster, takes in less water and stays much cooler than neoprene.

Outer shell	Super-duty nylon			Ultra-durable neoprene			Ecoprene
Colors available	Men's: Grey (09), Orange (12) Ladies: Grey (09), Pink (36)	Men's: Red (30), Green (70) Ladies: Red (30), Green (70)	Hi-Vis Yellow (26), Black (90)	Hi-Vis Yellow (26)	Men's: Orange (12), Black (90) Ladies: Black (90)	Red (30), Green (70)	Yellow (10)
Lightweight	●●●	●●●	●●●	●●●	●	●	●●
Quick-dry	●●●	●●●	●●●	●●●	●	●	●●●
UV tested fabric	Yes	Yes	Yes	Yes	Yes	Yes	Yes
Insert / Interior	Combination of PVC and polyethylene foam (light, supple, comfortable, higher buoyancy)	Combination of PVC and polyethylene foam (light, supple, comfortable, higher buoyancy)	Polyethylene foam	Combination of PVC and polyethylene foam (light, supple, comfortable, higher buoyancy)	Soft, beveled PVC foam (supple, comfortable, higher buoyancy)	Soft, beveled PVC foam (supple, comfortable, higher buoyancy)	Soft PVC foam (supple, comfortable, higher buoyancy)
Mesh drain panels (Evacuate water to lighten the PFD when wet)	No	No	No	No	Yes	Yes	Yes
Armholes cut large (Better comfort / ease of movement)	Yes	Yes	Yes	Yes	Yes	No	Yes
Woven straps (Better comfort and adjustments)	Men's: 4 Ladies: 4 (Ladies' Canadian PFD: 3)	Men's: 4 Ladies: 4 (Ladies' Canadian PFD: 3)	4	0 - 30 lb: 2 30 - 50 lb: 3 50 - 90 lb: 3	2	2	2
Quick release buckle	Yes	Yes	Yes	Yes	Yes	Yes	Yes
Heavy-duty zipper	N/A	N/A	N/A	N/A	Yes	Yes	Yes
Loop at the back neck	Yes	Yes	Yes	No	Yes	No	Yes
D-ring for lanyard	Yes	Yes	Yes	N/A	Yes	N/A	Yes
Special features	• Seat contour system for increased comfort while seated.	• Seat contour system for increased comfort while seated.			• Split tail comfort design		• Anatomically cut
							• Dries faster, takes on less water and stays much cooler than neoprene

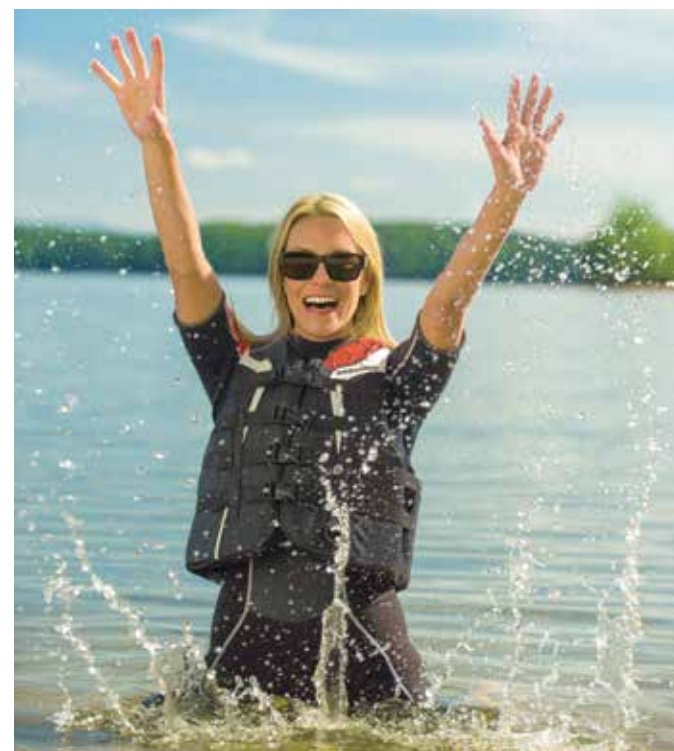

These charts show body measurements. Be sure to measure yourself to find the accurate size.

HOW TO MEASURE
For best results, have someone else take measurements. Measure body in swimsuit or underwear. Tape must be snug but not tight. If measurements fall between two sizes, order the larger size.

HEIGHT
Stand with back straight, without shoes; measure from the top of the head to the floor.

CHEST
Measure under your arms, around the fullest part of your chest.

WAIST
Measure around your natural waistline, keeping one finger between the tape and body.

HIPS
Stand with legs together, measure around the fullest part of hips, ensuring the tape is level.

PFDs

Men's Motion / Vibe

SIZE	XS	S	M	L	XL	2XL	3XL	4XL
Chest (cm)	76-84	84-94	94-104	104-114	114-124	124-135	135-145	145-155

Ladies' Motion / Vibe

SIZE	XS	S	M	L	XL	2XL	3XL	4XL
Chest (cm)	76-84	84-94	94-104	104-114	114-124	124-135	135-145	145-155

Navigator

SIZE	XS	S/M	L/XL	2XL/3XL	4XL/6XL
Chest (cm)	71-81	81-102	102-132	127-152	155-168

Men's Freewave

SIZE	S	M	L	XL	2XL	3XL
Chest (cm)	84-94	94-104	104-114	114-124	124-135	135-145

Men's Airflow

SIZE	S	M	L	XL	2XL
Chest (cm)	84-94	94-104	104-114	114-124	124-135

Ladies' Freewave / Airflow

SIZE	S	M	L	XL	2XL
Chest (cm)	76-84	84-91	91-99	99-107	107-114

Force

SIZE	XS/S	M	L	XL	2XL/3XL
Chest (cm)	86-91	94-99	99-104	104-109	112-119

Jr. Freewave

SIZE	OS	SIZE	S	M	L
Weight (kg)	63.5-74		0 - 14	14 - 23	23 - 41

Kids' Sandsea

SIZE	S	M	L
Weight (kg)	0 - 14	14 - 23	23 - 41

WETSUITS

Men's

SIZE	S	M	L	XL	2XL	3XL
Height	1.68-1.73	1.73-1.80	1.80-1.88	1.83-1.90	1.83-1.93	1.83-1.93
Weight (kg)	59-68	68-79	79-91	88-100	98-107	107-116

Ladies'

SIZE	6	8	10	12	14
Height	1.57-1.63	1.63-1.70	1.68-1.75	1.70-1.78	1.73-1.78
Weight (kg)	50-52	54-59	59-64	64-68	68-73

Kids

SIZE	6	8	10	12	14
Height	1.19-1.37	1.37-1.42	1.42-1.47	1.47-1.52	1.52-1.60
Weight (kg)	23	27	32	36	41

GLOVES (MEASURE PALM WIDTH)

SIZE	XS	S	M	L	XL	2XL	3XL
cm	7.6	8.3	9	10	11.4	13	14

What code represents your size?
1. Find your size
2. The corresponding code is THE CODE you use to complete the part number on your order. Example: 440227_90 Size: M = code "06", therefore 4402270690

Order Chart

SIZE	ONE SIZE	XS	S	M	L	XL	2XL	3XL	4XL	XS/S	S/M	L/XL	2XL/3XL
CODE	00	02	04	06	09	12	14	16	18	90	72	73	74

SIZE	4	6	7	8	9	10	11	12	14	26	28	30	32	34	36	38	40	42	43	0-30	30-50	50-90
CODE	23	25	27	28	29	30	31	32	34	89	36	37	38	39	40	41	42	43	60	62	64	

SPORTSWEAR

Men's Tops

SIZE	S	M	L	XL	2XL	3XL
Chest (cm)	91-97	99-104	107-112	117-122	127-132	137-142
Waist (cm)	76-79	84-89	91-97	104-109	114-122	127-132
Arm length (cm)	84	84	86	86	89	89

Men's Technical Boardshorts

SIZE	28	30	32	34	36	38	40	42
Waist (cm)	71-76	76-81	81-86	86-91	91-97	97-102	104-107	107-112
Hips (cm)	84-89	89-94	94-99	99-104	104-109	109-114	114-119	119-124

Ladies' Tops / Dress

SIZE	XS	S	M	L	XL	2XL
Chest (cm)	83-85	88-90	93-97	100-104	109-116	119-126
Waist (cm)	62-65	67-70	72-76	80-84	89-94	99-104
Low hips (cm)	88-90	93-95	98-102	105-109	114-119	124-130
Arm length (cm)	74	76	79	81	81	81

Ladies' Technical Boardshorts

SIZE	4	6	8	10	12	14
Waist (cm)	61-66	66-71	71-76	76-81	81-86	86-91
Hips (cm)	86-91	91-97	97-102	102-107	107-112	112-117



 The Vehicle Gloves feature touch-screen technology that allows operation of smart device screens.



“These gloves fit perfectly and provide great grip.”
— Mark Quavillon



ATTITUDE FULL-FINGER GLOVES
286354 • XS, S, M, L, XL, 2XL, 3XL • Yellow (10), Orange (12), Black (90)
\$39.99



 **ATTITUDE SHORTY GLOVES**
Webbed hands to make glove removal easy.
286355 • XS, S, M, L, XL, 2XL, 3XL • Yellow (10), Orange (12), Black (90)
\$32.99



FULL-FINGER VEHICLE GLOVES
Full gloves with Touchscreen technology on index fingers and thumbs.
286450 • XS, S, M, L, XL, 2XL, 3XL • Black (90)
\$39.99



SHORTY VEHICLE GLOVES
Webbed hands to make glove removal easy.
286449 • XS, S, M, L, XL, 2XL, 3XL • Black (90)
\$32.99



Removable neoprene ankle protectors



SEA-DOO WATER SHOES
Attractive and trendy look in a lightweight design made of EVA with TPU support. Features include easy one-hand side lace system and mesh fabric for quick draining. Perforated sole for water evacuation with rubber insert outsole for anti-slip performance.
444184 • 7, 8, 9, 10, 11, 12 • Black (90)
\$79.99



 **SEA-DOO SANDALS**
Fashionable sandals with lightweight and comfortable design. Rubber insert in sole for anti-slip performance. Molded feet area.
444188 • 7, 8, 9, 10, 11, 12 • Black (90)
\$32.99



 **SEA-DOO RIDING BOOTS**
High cut neoprene boot for added comfort, grip and protection. Neoprene interior adds comfort and protection, while the mesh flow-through panels allow water to drain quickly. Naturally shaped, molded sole with arch support provides maximum comfort and grip. Fast and easy quick lace system includes lace storage pocket. Includes adjustable Velcro strap for a better fit at the ankle.
285807 • 6, 7, 8, 9, 10, 11, 12 • Black (90)
\$109.99



“The goggle-to-PFD cord is very convenient and ensures you always know where your goggles are. I can’t imagine how many sunglasses are on the bottom of the lakes.”
 — Tommy Bishop-Strahlo



SEA-DOO AMPHIBIOUS RIDING GOGGLES

Super strong and super lightweight goggles that float on the water. Aerodynamic design uses soft flexible frames that conform to the shape of any face while offering 100% UV protection. The suspended, anti-fog lenses are polarized and interchangeable. Also included: goggle-to-PFD attachment cord, hard case and pouch that doubles as cleaning cloth.

447723 • One size • Black with graphics (94)
 \$79.99



AMPHIBIOUS GOGGLES POLARIZED REPLACEMENT LENS

447791 • One size • Grey (09), Amber (95)
 \$21.99

AMPHIBIOUS GOGGLES CLEAR REPLACEMENT LENS

447792 • One size • Clear (00)
 \$21.99



SEA-DOO RIDING GOGGLES

Specially designed for watercraft applications to deliver the best eye protection available. Feature revolutionary patented hypoallergenic silicone seal offering the finest anti-fog solution plus mirrored, scratch-resistant and adjustable band. Package includes goggle-to-PFD attachment cord, branded storage hard case, with pouch that also doubles as a cleaning cloth.

447462 • One size • White (01), Yellow (10), Orange (12), Black (90)
 \$79.99



SEA-DOO DRY POUCH

1-litre volume splash proof protection for your small essentials. Made of lightweight material with a see-through TPU window and drybag style roll-down top with clips. Belt hook for easy carrying.

Note: Not intended for immersion service.
 469540 • One size • Yellow (10)
 \$19.99

 The multi-functional Sea-Doo Duffle Bag is designed to carry everything for a day on the water, separating food and drinks in a insulated pocket and a waterproof compartment for wet items.



Side pocket cooler



Waterproof compartment



Mesh inner pocket

SEA-DOO DUFFLE BAG

Specially designed for day trips or extended outings. Made of durable polyester with segmented mesh inner pocket and key hook. Bag features two special pockets: one is waterproof, the other is a cooler. Comes with carry strap and shoulder protector.

Measures 24" x 12" x 12" (60 cm x 30 cm x 30 cm).
 447731 • One size • Charcoal Grey (07)
 \$64.99



N **CHILL HOODY**
 Pullover hoodie with large 2-zippered pocket.
 78% Cotton, 17% Polyester, 5% Spandex
 286357 - S, M, L, XL, 2XL, 3XL - Charcoal Grey (07),
 Heather Grey (27), Blue (80)
 \$82.99



Sleeve cuff with hole for the thumb



“I don’t have to be on the water to live the Sea-Doo life.”
 — Jesse Burlew



N **POP TEE**
 Fitted V-neck t-shirt with silicone Sea-Doo logo print on left sleeve.
 96% Cotton, 4% Spandex
 286352 - S, M, L, XL, 2XL, 3XL - White (01), Heather Grey (27),
 Black (90)
 \$35.99



N **MEN'S PULSE BOARDSHORTS**
 Technical boardshort with advanced 4-way stretch fabric that is ultra light and dries quickly. Functions well in water and looks great out. Features mesh lining, tie waist closure and reinforced crotch seams. Has 3 front pockets and waterproof pouch located inside zipper pocket.
 88% Polyester, 12% Spandex
 286353 - 28, 30, 32, 34, 36, 38, 40 - Grey (09), Orange (12), Black (90)
 \$64.99

✓ The Pulse Boardshorts feature an integrated dry pouch inside the zippered pocket to keep essential carry-alongs dry.



N **FREEDOM CAP**
 Print on left side of cap with woven Sea-Doo logo on the back. Inner elastic helps ensure a good fit.
 97% Polyester, 3% Spandex
 286351 - S/M, L/XL - Black (90)
 \$19.99



Wear it. Live it. Share it. #SEADOOSPARKSTYLE

Post a picture of yourself wearing one of these star items.

EASY-BREEZY

There are many ways to rock the Sea-Doo Breeze Dress.

P. 30



P. 29

TIME TO CHILL



SHORT AND SLEEK
Technical boardshorts with the right casual look.

P. 29-33

The Splash Bikini Top offers three different adjustment points for maximum comfort on the water and off.



Back

SPLASH BIKINI TOP
Sport bikini top that offers good support with quick dry foam in cup. Hook adjustment at center back and on left side under mesh buckle.
57% Nylon, 31% Polyester, 12% Spandex
286359 - XS, S, M, L, XL, 2XL - Pink (36), Black (90)
\$54.99



LADIES' PULSE BOARDSHORTS
Fashionable boardshort with advanced 4-way stretch fabric that is ultra light and dries quickly. Functions well in water and looks great out. Features mesh lining, snap waist closure. Has 2 pockets. Waterproof pouch is included to keep small items dry.
88% Polyester, 12% Spandex
286356 - 4, 6, 8, 10, 12, 14 - White (01), Black (90)
\$54.99



BREEZE DRESS
Summer dress with frill accents around neckline and arms, plus an insert mesh on back yoke for comfort.
81% Cotton, 12% Spandex, 7% Nylon
286358 - XS, S, M, L, XL, 2XL - Charcoal Grey (07), Pink (36)
\$32.99



✓ The Classic Polo is constructed of bamboo fiber that actively promotes evaporation for cooling at the marina, office or golf course.



SEA-DOO CLASSIC POLO
3-button opening and silicone print logo.
78% Polyester, 22% Bamboo
286425 • S, M, L, XL, 2XL, 3XL • Grey (09)
\$42.99



SEA-DOO CLASSIC SHORTS
Technical boardshort for men with advanced 4-way stretch fabric that is ultra light and dries quickly. Functions well in water and looks great out. Features mesh lining, hook closure, reinforced crotch seams, front zipper pockets, plus rear and left front welt pockets with hidden Velcro closures.
88% Polyester, 12% Spandex
286433 • 28, 30, 32, 34, 36, 38, 40, 42 • Black (90)
\$65.99



SEA-DOO CLASSIC CAP
Lightweight adjustable cap that's perfect for summer use. Silicone Sea-Doo logo on right front, with metal adjuster at back.
100% Cotton
286430 • One size • White (01), Charcoal Grey (07)
\$21.99



SPIN CAP
Lightweight adjustable cap for summer weather. Woven logo on front, Sea-Doo logo on side, with metal adjuster at back.
100% Cotton
286431 • One size • Black (90)
\$21.99



ESCAPE TECHNICAL BOARDSHORTS
286428 • 28, 30, 32, 34, 36, 38, 40, 42 • Blue (80)

Functional in the water, fashionable out. Constructed of ultra light, quick drying fabric that stretches 4 ways. Design features include mesh lining, removable lightweight stretch neoprene inner short, tie closure, pocket with hidden Velcro closure and reinforced crotch seams.
91% Polyester, 9% Spandex
\$87.99



SPIRIT TECHNICAL BOARDSHORTS
286424 • 28, 30, 32, 34, 36, 38, 40, 42 • Mixed Color (18)



ELEVATE TEE
100% Cotton
286432 • S, M, L, XL, 2XL, 3XL • White (01), Black (90)
\$32.99



VERTICAL TEE
100% Cotton
286427 • S, M, L, XL, 2XL, 3XL • White (01), Heather Grey (27), Red (30)
\$32.99



LADIES' SEA-DOO SIGNATURE TEE
Fitted V-neck t-shirt made of stretchable fabric with gathered sideseams to highlight a feminine shape.
95% Cotton, 5% Spandex
286426 • XS, S, M, L, XL, 2XL • White (01), Raspberry (39)
\$35.99

✓ The ladies' Jive Technical Boardshorts with stretch neoprene inner liner offer superior protection while riding. It can be removed for casual comfort.



LADIES' JIVE TECHNICAL BOARDSHORTS
Features include ultra lightweight, quick drying 4-way stretch fabric construction with mesh lining. Design includes snap waist closure, right front zipper pocket and right rear welt pocket with hidden velcro closure and embroidered Sea-Doo logo at back.
91% Polyester, 9% Spandex
286429 • 4, 6, 8, 10, 12, 14 • Black (90)
\$64.99

ACCESSORIES

A full line of accessories for the new Sea-Doo Spark allows you to make it your own. Various products have been developed in conjunction with bringing the Sea-Doo Spark to the water to add functionality and style, making it a watercraft like no other.



The Chill Shade is a versatile sun shade that was engineered to be mounted on the Sea-Doo Spark while underway on the water or easily removed and set up on the beach, providing shade on the sunniest of days.



CHILL SHADE
Don't go looking for shade - bring it with you. The innovative Chill Shade provides versatile protection both on the water and the beach. It can even be used at speeds up to 35 mph (56 km/h) when properly set. The system can be easily installed while out on the water and stores conveniently on a Sea-Doo Spark model. Made of colorful netting, it comes with 2 pouches that can be used as sand anchors on the beach.
Sea-Doo Spark
295100574
\$149.99



SNAP-IN FENDERS
Protect your investment with easy to install and remove fenders designed specifically for Sea-Doo watercraft. Pre-molded holes front and rear on the Sea-Doo Spark models ensure a solid mount in the optimal spot. High visibility red color keeps them in sight. Sold in pairs. Patent pending. Requires Snap-in Fenders Installation Kit (295100550) to install on models other than Sea-Doo Spark.
Sea-Doo Spark
295100418
\$99.99



The Sea-Doo Spark transom step makes it easy to reboard from deep water after taking a swim or following a wake session. The Sea-Doo Step easily mounts on the transom and can be installed by any authorized Sea-Doo dealer in minutes.



SEA-DOO STEP
Convenient step with knee-friendly surface for deep water boarding. Installs easily on the right side of a watercraft and can hold up to 250 lb (113 kg).
Sea-Doo Spark
295100494
\$99.99

SNAP-IN FENDERS INSTALLATION KIT
(Not illustrated)
Installation kit for 2009 and up watercraft lets you enjoy the fastest, easiest way to install protective fenders on your watercraft.
295100550
\$19.99



“So this is the most playful watercraft I’ve ever been on.”
— Corrie Wassum



CARGO NET
With a 4L (1.05 US gallon) capacity, this cargo net keeps regularly used items in place. The mesh material allows water to drain out easily and air to circulate, perfect to stow your snap-in fenders, tow ropes or diving mask. An elastic cord allows you quick access, while keeping your items secured.
Sea-Doo Spark
295100559
\$39.99

FRONT STORAGE BIN KIT
Soft-sided design matches the contours of the Sea-Doo Spark model to maximize storage. Polyurethane construction protects items from rough waves and those spirited rides. Drain holes at bottom. Lid is included. Maximum storage capacity: 28 liters.
Sea-Doo Spark
295100504
\$149.99

FRONT DEFLECTOR LID KIT
Made of polypropylene, this deflector directs water away from the driver’s feet and legs on those colder days, but removes quickly when things heat up.
Sea-Doo Spark
295100553
\$89.99

GRIP MAT
Developed specifically for the Sea-Doo Spark, this EVA foam material grip mat ensures both comfort and traction as you play on the water. Allows to reboard to a cushioned platform while protecting it from wear and tear. Easy to install with the double sided tape attached to the mat.
Sea-Doo Spark
295100556
\$109.99

SIDE PROTECTOR
This 3-piece rubber formed protector is specifically designed for the Sea-Doo Spark. Its curves and angles follow the lines of the unit to enhance the look while protecting from small impacts and wear. Allows installation of the Snap-in Fenders and maintenance with no problems.
Sea-Doo Spark
295100575
\$149.99



GRIP MAT EXTENSION
Developed specifically for the 3up Sea-Doo Spark, this EVA foam material grip mat ensures both comfort and traction as you play on the water. Allows to reboard to a cushioned platform while protecting it from wear and tear. Easy to install with the double sided tape attached to the mat. For full protection on a 3up, add the Grip Mat (295100556).
Sea-Doo Spark
295100571
\$49.99

AVAILABLE
FEBRUARY
2014

MANUAL REVERSE KIT
Install a reverse lever on your non iBR equipped Sea-Doo Spark. This kit can be easily added to your Sea-Doo Spark and will aid immensely in docking manoeuvres and trailer loading. A lever located on the left side makes it easy to engage reverse and avoid the need for aggressive or dangerous manoeuvres.
Sea-Doo Spark
295100596
\$329.99



EXCLUSIVE ATTITUDE GRAPHIC KITS

11 DIFFERENT GRAPHIC KITS AVAILABLE IN 3 LEVELS OF CUSTOMIZATION (LIGHT, MEDIUM OR FULLY WRAPPED), AND COLOR OPTIONS FOR A TOTAL OF 60 COMBINATIONS.



Cubism Dream-Orange



BLACK SEA



RACING NUMBER - GREY



CUBISM DREAM



RAYS



FAR OUT



SUN SHADE



X RAY



CLASSIC



SUNBURST



TORN



LAZER

Add a little attitude with graphic kits. These Sea-Doo exclusive Attitude Graphic Kits are the product of choice for avid Sea-Doo Spark riders. Whether you want to make your watercraft stand out from the crowd or give it a facelift, this is the product for you. Customizing kits also available for more color logo options. The digital print designs will not fade in sunlight and the vehicle wraps are designed to bond to “hard-to-stick” surfaces as well as low energy surfaces.

Sea-Doo Spark



If you want your Sea-Doo Spark to be as unique as your signature, visit www.scseadoographics.com to see our full lineup of graphic kits.



280000555 / 280000617



280000664



280000472

A Sea-Doo storage cover is essential to ensure your Sea-Doo is protected from the elements and to maintain a fresh appearance. There's a perfectly fitting cover for every model in the line.



280000460*, 280000472*, 280000587*

280000461*

280000664

280000462-

280000596, 280000543

280000597

280000665

280000598



280000464*

280000369*

280000278*

280000555

280000617

COVERS

Complete and versatile lineup of watercraft covers. Solution-dyed fabric offers easy handling and increased UV resistance. Strapless design provides easy installation. Patented air release vent system for trailering.

FITS	COLORS	SKU	PRICE
RXT iS 260 (2009 and up), GTX iS 215 (2010 and up), GTX LTD iS 260 (2009 and up)	Black / Light Grey	280000460	\$259.99
GTX 155/215, RXT-X 260, Int'l RXT-X 260 and RXT 260 (2010 and up), models without suspension GTX LTD 215 (2014)	Black / Light Grey	280000472	\$259.99
GTX-S 155 (2012)	Black / Light Grey	280000587	\$259.99
WAKE Pro 215 (2010 and up)	Black / Viper Red**	280000461	\$259.99
	Black	280000664	\$259.99
RXP & RXP-X (2004 - 2011)	Black / Mortar Grey	280000464	\$259.99
GTI & GTI SE (2006 - 2010), WAKE 155 (2009 - 2010)	Black / Light Grey	280000462	\$259.99
WAKE 215 (2007 - 2009)	Mortar Grey / Black	280000369	\$244.99
GTX, except LTD iS package (2007 - 2009)	Mortar Grey / Black	280000278	\$224.99
GTR 215 (2012 and up)	Black / Light Grey	280000596	\$259.99
RXP-X 260 (2012 and up)	Black / Light Grey	280000543	\$259.99
WAKE 155 (2011 and up)	Black / Viper Red**	280000597	\$259.99
	Black	280000665	\$259.99
GTI 130 (2011 and up), GTI SE 130 / 155 (2011 and up), GTS Rental (2011 and up), GTS (2011 and up)	Black / Light Grey	280000598	\$259.99
RXT-X aS	Black / Light Grey	280000586	\$254.99

SEA-DOO SPARK COVERS

Strapless design allows easy installation with solution-dyed fabric for increased UV resistance. Features include patented air release vent system for trailering and interior pouch to store cover when not in use. Openings to accommodate the Speed Tie system and snap-in fenders while docked, plus one at the back for ski eye under the seat.

2up	Black	280000555	\$219.99
3up	Black	280000617	\$239.99

PWC COVER HOOK REPLACEMENT KIT

(Not illustrated)
Replacement sew-in attachment hooks. Hook under watercraft bumper. Set of 2.

All PWC covers

295100407

\$4.49

*Convenient openings for easy access to the Speed Tie mooring system. **Until stocks depleted. Note: For prior model years, please ask your dealer for details.



“The Speed Tie makes tying up so easy and fast. No more tangled dock lines, no more wet ropes on top of t-shirts in your storage. The dock lines are out of sight, out of mind until you need them.”
— Jesse Burlew

▶ **WATCH** how easy the Sea-Doo Speed Ties work!
store.sea-doo.com/video



SEA-DOO SPEED TIE
Fully-integrated watercraft mooring system, providing the ultimate in convenient, quick and secure docking. Snap-out plates front and rear on Spark models allow for easy installation and positioning of the Sea-Doo Speed Tie system. Stores 7' (2.1 m) of rope and locks to desired length. Standard equipment on the GTX LTD iS. Sold in pairs.



-  **Sea-Doo Spark**
295100496
\$199.99
- RXP-X (2012 and up)**
295100466
\$184.99
- GTR (2012 and up), GT1, GT1 SE and GTS (2011 and up), GTX without suspension (2010 and up), WAKE Pro, WAKE 155, RXT & RXT-X without suspension (2010 and up)**
295100422
\$184.99

 The Sea-Doo Speed Tie makes docking easier than ever with seven feet of retractable dock lines at the helm and on the transom that effortlessly stows out of site. The Speed Tie system is a must-have accessory that frees up storage space and ensures you have a dock line at all times.

SEA-DOO SPEED TIE FOR DOCK
Same exclusive mooring system available as a PWC accessory, adapted for dock mounting. Provides quick and secure mooring for all watercraft, eliminating excessive rope on deck. Bolts directly to dock, stores 7' (2.1 m) of rope and locks to desired length. Sold individually.
295100336
\$114.99



DESS FLOATING SAFETY LANYARD
Replacement DESS lanyard for all models.
All models
278002199
\$65.49

LEARNING KEY LANYARD
Reduce the speed of your boat and allow less experienced riders to learn gradually.
DI & 4-TEC Models
278002203
\$83.99



MOORING LINE
Solid UV-protected, highly visible polypropylene buoyant rope.

12' (3.7 m) 295100008 - Purple \$28.49	20' (6 m) 295100233 - White 295100231 - Blue \$36.99
15' (4.6 m) 295100060 - Yellow 295100240 - White 295100239 - Black 295100236 - Blue 269501288 - Twilight Blue 295100235 - Red \$34.99	25' (7.6 m) 295100234 - Blue 295100232 - White \$44.99



FENDER
Polyform strength and dependability with a vinyl valve system for quick, flexible adjustment of firmness. One fender and one rope per package. Fender ties included.
295100372 - White
\$29.99

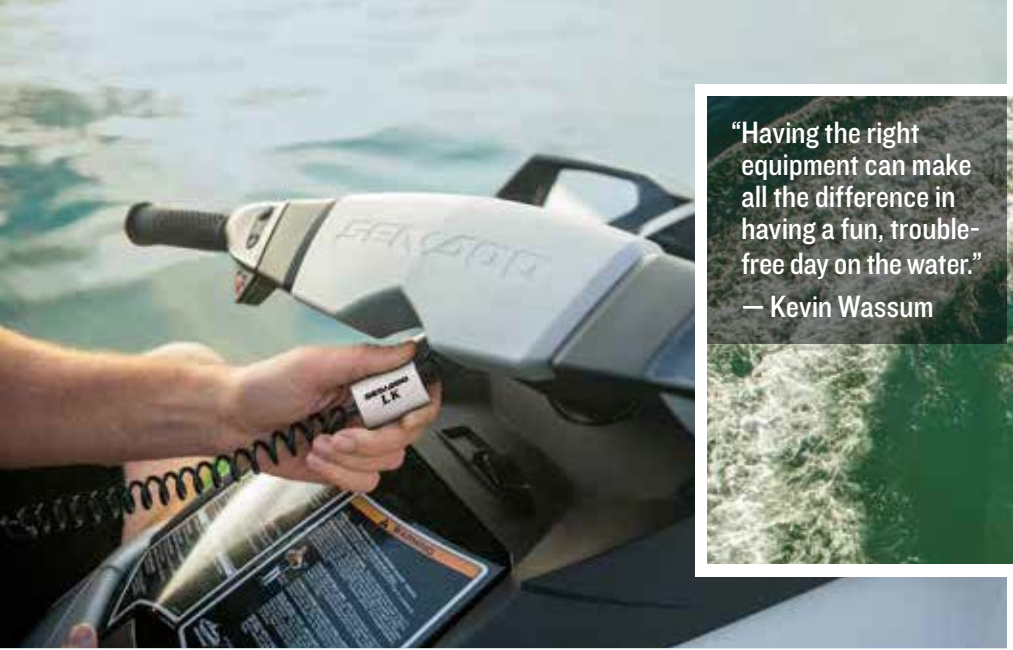

“Having the right equipment can make all the difference in having a fun, trouble-free day on the water.”
— Kevin Wassum



TUBE TOW ROPE
White 50' (15.2 m) heavy-duty tow rope.
All Boats and 3-seater PWCs
295100207
\$49.99



SANDBAG ANCHOR
600-denier polyester bag with up to 35 lb (16 kg) sand/rock capacity. 21' (6.4 m) polypropylene cord. Stores easily and floats when empty. Measures 12 1/2" x 9" (31.8 cm x 22.9 cm).
295100211 - Yellow
295100212 - Blue
295500589 - Red
295100286 - Sand
\$49.99



DOCK TIE
Moor your boat with these floating Sea-Doo shock cushioned nylon ropes. Provides security and a little give to keep your watercraft and dock attached. One per package.
295100047
\$34.99



ANCHOR
11 lb (5 kg) Fluke style anchor with slip ring provides sure grip.
295100046
\$64.99

ANCHOR PACKAGE
11 lb (5 kg) folding anchor with storage bag to protect your watercraft.
295100343
\$99.99



THROW LINE BAG
Floating storage bag and 50' (15 m) of buoyant yellow rope. Throw line bags provide added safety.
295500832
\$32.99



ANCHOR
High performance Richter Anchor. Provides superior grip and easy retrieval. Holds all boats up to 22 ft. in length.
295100289
\$104.99



RETRACTABLE SKI PYLON

High-rise pylon keeps rope out of water for better watersport fun. Features built-in spotter grab handles and retracts out of the way when not in use.

RXT-X, GTX, RXT, except models with iS, GTI & GTS (2011 and up), GTR (2012 and up), GTX LTD (2014)

295100457

\$394.99

GTI (2006 - 2010)

(Not illustrated)

295100304

\$344.99



WAKEBOARD RACK

Specially designed to fit all Sea-Doo watercraft. Each rack holds one wakeboard while offering safe and easy board storage. Sold individually.

GTX with iS, RXT, RXT-X & Wake Pro (2010 and up), GTI & GTS (2011 and prior), GTR (2012 and up), GTX Ltd (2014)

295100453

\$189.99

GTI (2006 - 2010)

(Not illustrated)

295501037

\$189.99



SHOCK TUBE

Protects passengers from ski rope kick-back and keeps ski ropes away from impellers. Durable nylon cover over closed-cell foam.

295100210 • Blue

295500597 • Red

295100287 • Sand

295100209 • Yellow

\$30.99



SKI EYE

Replaces existing U-ring for easy towing of skiers and tubes.

GTX, GTS, GTI, RXT, GTR & RXP-X (2012)

291002351

\$30.99



"You want to bring everything that you need with you for a fun-filled on the water. The BRP designers do a great job integrating practical Sea-Doo storage accessories."

— Jeremy Schandelmayer



SEA-DOO DRY POUCH

One litre splash-proof protection for your small essentials. Made of lightweight material with a see-through TPU window and drybag-style roll-down top with clips. Belt hook for easy carrying. **Note: Not intended for immersion service.**

4695400010 • Yellow

\$19.99



25L



10L

DRY BAGS

Watertight bags. Puncture-resistant PVC coated polyester fiber material. Reinforced bottom. Offers in 10 L or 25 L capacity.

269501744 • Black • 10 L (2.6 US gallon)

\$34.99

Includes a shoulder strap. Resistant polyester 420D with TPU coating.

269001936 • Black • 25 L (6.6 US gallon)

\$54.99



STORAGE TRAY

Complete with molded compartments for convenient storage of your watercraft safety kit, cooler and watertight foam insulated otter box. Also great for wallets, glasses and cell phones. Netting provides secure storage for towels, clothing and sandals. Comes with a practical integrated carry handle.

GTX & RXT (2009 and prior), except models with iS

269501478

\$74.99



FRONT STORAGE TRAY

Optimizes storage space on PWCs. 12 L (3.2 US gallon) capacity.

RXP-X (2012 and up), GTI & GTS (2011 and up), GTR (2012 and up), WAKE 155

295100583 • Grey

\$169.99



GLOVE BOX ORGANIZER KIT

Kit includes glove box liner and semi-rigid splash-resistant portable case. Liner cushions the inside of the glove box to provide insulation. Case fits perfectly in the glove box and is easily accessible when opening the glove box cover. This semi-rigid case is perfect for carrying and storing valuables, e.g. keys, cell phone, wallet, sunglasses.

Models on S³Hull™, all iS models

295100327

\$144.99



SKI MODULE
 Activates ski mode. Offers a choice of different preset acceleration curves for perfect launch every time when towing a skier or wakeboarder, plus steady tow speed. User-friendly interface on gauge. Simple plug-in connection. Includes hardware necessary for installation.

2011 and up models with iBR™* Standard feature on WAKE models. 295100432 \$149.99	2010 models with iBR **295100380 \$149.99
---	--



CRUISE CONTROL AND SKI MODE
 Activates ski mode, cruise control and slow speed mode through a switch mounted on the handlebar. Ski mode offers choice of different pre-set acceleration curves for consistent launch every time when towing a skier or wakeboarder. User-friendly interface on gauge. Simple plug-in connection. Includes switch, cap and hardware necessary for installation.

2011 models with iBR* **295100455 \$234.99	2010 models with iBR 295100383 \$234.99
---	--

44 *Intelligent Brake and Reverse (iBR)
 **Until stocks depleted.

“Sea-Doo has been involved with Wake sports since the beginning; they get it. The Wake-specific accessories set these watercraft apart from all the others.”

— Ben Horan



12-VOLT OUTLET AND INSTALLATION KIT
 Installs inside the Sea-Doo Spark glove box. Use this 12V outlet to charge your phone or GPS unit. Includes a cover to prevent material intrusion.

Sea-Doo Spark, GTI, GTS, GTR, WAKE 155 295100577 GTX & RXT models (except models S and with iS), WAKE Pro 295100612 \$54.99

ELECTRIC CONNECTION KIT
 (Not illustrated)
 A very convenient and safe way to add electrical accessories. Installs plug and play style to the Spark wiring harness with an easy installation and the electrical connection kit allows you to add 2 electrical accessories. Required in order to install the Sea-Doo Spark Depth Finder (295100590).

Sea-Doo Spark 295100599 \$99.99
--

SPEED AND WATER TEMPERATURE SENSOR
 (Not illustrated)
 Integrated boat speed and water temperature sensor. Simple plug-in connection with mounting hardware included.

GTI (2006-2010) 295100309 \$99.99
--



DEPTH FINDER
 Displays the water depth below the hull. Plug 'n' play connection.

Sea-Doo Spark 295100590 \$339.99 All GTX & RXT models with 4-TEC engines (2009 and prior, except 2002), models with iS, GTI (2008-2010) 295100324 \$404.99	2011 and up models with iBR*, GTS (2011 - 2013) 295100421 \$354.99 2010 and prior iS models, GTX (2010), RXT, RXT-X and WAKE Pro 295100332 \$404.99
---	--



X PACKAGE MODULE
 Activates X Package functions on gauge: lap timer, fuel time and distance to “empty”, average and top speed/RPM display, and engine temperature. User-friendly interface on gauge. Simple plug-in connection. Includes hardware necessary for installation.

2011 and up models with iBR* Standard feature on X models. 295100431 \$149.99 2010 models with iBR* 295100381 \$149.99
--



VARIABLE TRIM SYSTEM MODULE
 Activates and provides instantaneous VTS adjustment. Switch mounted on handlebar allows fine tuning of watercraft trim angle while riding. Simple plug-in connection. Includes switch, cap and hardware necessary for installation. This accessory cannot be installed on 2012 and up models.

2011 models with iBR*, without VTS switch 295100433 \$189.99	2010 models with iBR* 295100379 \$189.99
---	---

*Intelligent Brake and Reverse (iBR)



LADDER
Retractable boarding step designed specifically for your watercraft. Spring-loaded to stay in the UP position.
All models 2006 and up
295100552
\$264.99



RATCHET TIE DOWN
400 lb (181 kg) safe working load. 1" x 10' (2.5 cm x 3 m) strap with Sea-Doo, Ski-Doo and Can-Am logos. Deluxe ratchet with rubber handle. Coated S hooks. Pack of 2.
All PWCs & Boats
860200447
\$16.99



RATCHET TIE DOWN
Designed specifically for strapping a PWC to a trailer: one strap does it all. Custom 4-hook system is ideal for quick installation/removal without separating strap from ratchet. Fingertip tension adjustment with deluxe ratchet. 1" (2.5 cm) Sea-Doo branded polyester strap features hull protector pads, extra strap holder and coated hooks.
All PWCs & Boats
295100389
\$23.49



PERFORMANCE INTAKE GRATE
Improve your high speed handling and stability by replacing your stock intake grate with this anodized aluminum one.
RXP-X (2011 and prior)
295100435
\$174.99



HANDLEGRIPS KIT
Better control and comfort using dual density rubber design. Available in six colors that fit all 2000 and up watercraft.
Sold in pairs
295500976 - Blue / Black
295500977 - Earth Grey / Black
295500978 - Green / Black
\$21.99
295500979 - Red / Black
295500980 - Pewter Grey / Black
295500981 - Yellow / Black
\$21.99
Sold individually
277001336 - Slate Grey
\$13.49



FIRE EXTINGUISHER
A requirement for any boat. Ideal for grease, oil and electrical fires. Canadian Coast Guard approved. Note: White color not available in Canada.
295100005 - Red
\$26.99



SAFETY EQUIPMENT KIT
This kit includes all the essentials for your watercraft. 50' (15 m) of buoyant heaving line, bailer, whistle and watertight flashlight.
295100330
\$24.99
WHISTLE
This "pea-less" whistle produces an extremely loud, high, penetrating sound that can be heard over long distances. Unaffected by water; just clear with one quick blow.
295500554
\$9.49



24-UNIT STRIPE DECALS
Package of 24 decals, 4 of each design.
4.5" x 4.5" (11 cm x 11 cm).
295100347
\$129.99



SEA-DOO PARADISE DECAL
Set of 2. 10" x 8" (25 cm x 20 cm).
295100338
\$17.99



SEA-DOO WAVE DECAL
Set of 2. 10" x 8" (25 cm x 20 cm).
295100339
\$17.99



SEA-DOO X PACKAGE DECAL
Set of 2. 10" x 8" (25 cm x 20 cm).
295100340
\$17.99



SEA-DOO SURF DECAL
Set of 2. 10" x 8" (25 cm x 20 cm).
295100337
\$17.99



SEA-DOO FLOWER DECAL
Set of 2. 10" x 8" (25 cm x 20 cm).
295100341
\$17.99



SEA-DOO TROPICAL DECAL
Set of 2. 10" x 8" (25 cm x 20 cm).
295100342
\$17.99

REGISTRATION KIT
This high quality UV-resistant registration kit is new and improved. Easier to install without deformation, with a glue that will adhere to all surfaces, including Sea-Doo Spark. Available in two contrasting colors that meet mandatory regulations for height and size. Dimensions: 3" (7.6 cm)
All PWC models
295100570 - Black
295100578 - Light Grey
\$34.99

CUSTOMIZE YOUR SEA-DOO SPARK

WITH FULLY INTEGRATED ACCESSORIES



SNAP-IN FENDERS + CARGO NET



FRONT STORAGE BIN KIT



SEA-DOO STEP + GRIP MAT EXTENSION



DEPTH FINDER

Build your own Sea-Doo Spark

Select fully integrated accessories and graphic kits that will make your Sea-Doo Spark unique to you.



www.SparkSomeFun.com



The Sea-Doo Move family of trailers offer user-friendly features and are engineered to fit the hull of your Sea-Doo watercraft perfectly, making loading and unloading really simple. Choose the Sea-Doo Move that suits your need.

▶ WATCH the Sea-Doo Move Trailers video at: store.sea-doo.com/video

SEA-DOO SPARK MOVE II TRAILER

A trailer made specifically for your Sea-Doo Spark PWC. Weighing 40% less than other Move II models, and 25% shorter, the new Sea-Doo Spark Move II totally redefines traveling light. You can actually tow it with a standard sedan since it's under 1,500 lb. even when loaded with two Sea-Doo Spark units. And it comes pre-calibrated, so you're good to go, from the get-go.

✓ The Sea-Doo Move family of trailers won the prestigious NMMA Innovation Award in the watersports equipment category for "making launching and retrieving faster and easier, while keeping safety in mind."



GETTING THERE IS HALF THE FUN

A watercraft trailer does much more than get your Sea-Doo from your home to the water. Your Sea-Doo is a premium piece of high performance hydrodynamics and should be cradled by something of equal quality, such as a Sea-Doo Move Trailer. The most active Sea-Doo rider may spend 50 days a year on the water. That leaves 315 days, or 8260+ hours your Sea-Doo is NOT on the water.

The rest of that time your Sea-Doo rests on top of your trailer on its way to the water or back from it, or waiting for the next adventure. Ensure your watercraft is resting on strong, clean roller or carpeted bunks and your trailer's capacity is rated to safely cradle your watercraft load. Owning a quality Sea-Doo Move Trailer will help ensure your next trip to the local ride spot or 100+ miles family trip is trouble free.

— Willy Carmine,
Route One Motorsports President.

CHOOSE THE SEA-DOO MOVE THAT SUITS YOUR NEEDS.

SEA-DOO MOVE TRAILERS

- The iCatch™ system allows you to spend less time on the ramp and more time in the water, while the walk pad serves as guidance when the trailer is underwater.
- Roller bunk system simplifies unloading and loading.
- Fully adjustable carpeted bunks (side-to-side/front-to-back) allow you to change bunk angles to fit all watercraft.
- Custom frame design requires less water to load and unload watercraft.
- Sealed maintenance-free wheel bearings for added peace of mind.
- All models are available in galvanized frame for extended life in all weather conditions or in a black painted version.
- Adjustable bunk system and catcher adapt to different types of Sea-Doo watercraft, and help properly position watercraft to improve handling while towing.

*Models shown with optional accessories.

Sea-Doo Move I with iCatch and walk pad

iCatch bow cup included

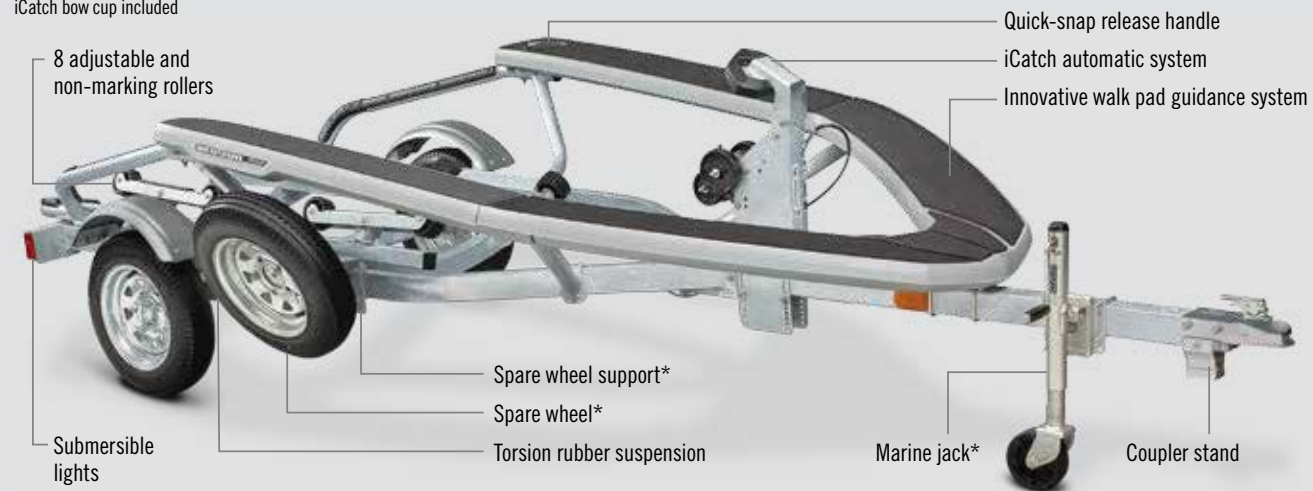

With torsion suspension

Overall length	4.1 m	Coupler	5 cm
Overall width	1.8 m	Approx. weight	163 kg
Width between walk pad	1.3 m	Carrying capacity	519 kg
Overall height (walk pad)	90 cm	Tire size	4.80" x 12"
Overall height (iCatch)	107 cm		

The iCatch Move trailer is the most innovative trailer system available, making trailering, launching and loading effortless. The roller bunks and loading rails guide the watercraft into the proper position and the iCatch automatically "catches" the watercraft, locking it in place to pull out of the launch ramp.

*Models shown with optional accessories.

Sea-Doo Move II with iCatch

iCatch bow cup included



With torsion suspension

Overall length	5.13 m	Coupler	5 cm
Overall width	2.6 m	Approx. weight	268 kg
Width between fenders	2.5 m	Carrying capacity	1,070 kg
Overall height (center rail)	1.3 m	Tire size	ST185/80D13
Overall height (iCatch)	1.2 m		

Sea-Doo Move II



With leaf springs suspension

Overall length	5.18 m	Coupler	5 cm
Overall width	2.5 m	Approx. weight	220 kg
Width between fenders	2.1 m	Carrying capacity	1,114 kg
Overall height (fenders)	74 cm	Tire size	ST185/80D13
Overall height (winch)	99 cm		

▶ WATCH how the Sea-Doo Trailers' unique features can let you fully enjoy your journey!
store.sea-doo.com/video

Sea-Doo Move I I250



With torsion suspension or With leaf springs suspension (Not illustrated)

Overall length	3.8 m	Coupler	5 cm
Overall width	1.5 m	Approx. weight	105 kg
Width between fenders	1.2 m	Carrying capacity	560 kg
Overall height (fenders)	61 cm	Tire size	4.80" x 12"
Overall height (winch)	80 cm		

Sea-Doo Move I Extended I250



With leaf springs suspension

Overall length	4.08 m	Coupler	5 cm
Overall width	1.5 m	Approx. weight	113 kg
Width between fenders	1.4 m	Carrying capacity	567 kg
Overall height (fenders)	61 cm	Tire size	4.80" x 12"
Overall height (winch)	80 cm		

Sea-Doo Move I Extended I500



With leaf springs suspension

Overall length	4.1 m	Coupler	5 cm
Overall width	1.6 m	Approx. weight	125 kg
Width between fenders	1.2 m	Carrying capacity	680 kg
Overall height (fenders)	61 cm	Tire size	5.30" x 12"
Overall height (winch)	80 cm		



Sea-Doo Spark Move II



With leaf spring suspension

Overall length	3.8 m	Coupler	5 cm
Overall width	2.5 m	Approx. weight	163 kg
Width between fenders	2.2 m	Carrying capacity	567 kg
Overall height (center rail)	37 cm	Tire size	4.80" x 12"
Overall height (iCatch)	87 cm		

SEA-DOO MOVE TRAILERS



WALK PAD CARPET KIT
Complete carpet kit improves footing and look of Sea-Doo Move I trailer, with walk pad, by adding traction mats. Kit includes four 3M self-adhesive carpets for fast, clean installation.
Sea-Doo Move I with Walk Pad Trailers
295100398
\$139.99

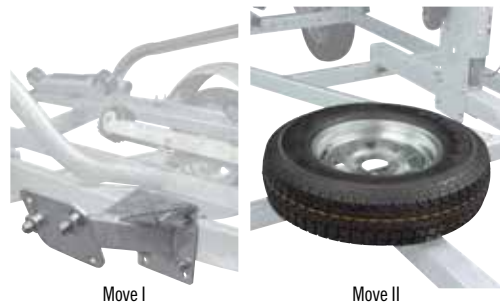

SPARE WHEEL SUPPORT
Includes hardware necessary for installation.
Sea-Doo Move I Trailers
295100500 - Painted Black
295100499 - Galvanized
\$74.99

Sea-Doo Move II Trailers
295100501 - Zinc Coated
\$74.99



SPARE WHEEL
Steel spare wheel and tire.
Sea-Doo Move I Trailers
12" (30 cm)
295100409 - Galvanized
295100410 - Painted Silver
\$104.99

KEY FEATURES INCLUDED

	SIMPLE				DOUBLE		
	Move I 1250	Move I Extended 1250	Move I Extended 1500	Move I with iCatch and walk pad	Move II	Move II with iCatch	Sea-Doo Spark Move II
Adjustable iCatch system				•		•	
Rugged and durable hot-dipped galvanized finish (optional)	•	•	•	•	•	•	•
Rugged and durable black powder-coat finish (standard)	•	•	•	•	•	•	•
8 adjustable non-marking rollers (4" (10 cm) left to right, 8-degree angle)				•			
16 adjustable non-marking rollers (4" (10 cm) left to right, 8-degree angle)						•	
Blow molded walk pad				•			
2 adjustable wooden bunks with carpet	•	•	•				
4 adjustable wooden bunks with carpet					•		
4 non-adjustable wooden bunks with carpet							•
Adjustable winch strap(s)	•	•	•		•		
Multi adjustable axle (torsion only)	•			•		•	
Torsion rubber suspension (for smoother ride) (optional on Sea-Doo Move I)	•			•		•	
Leaf spring suspension (optional on Sea-Doo Move I)	•	•	•		•		•
Tire size: 4.80" x 12"	•	•	•	•			•
Tire size: 5.30" x 12"							•
Tire size: ST185/80D13					•	•	
Ground wired	•	•	•	•	•	•	•
Fully enclosed wiring harness	•	•	•	•	•	•	•
Submersible lights	•	•	•	•	•	•	•
Coupler stand				•		•	
Suspended plastic fender for better splash protection	•	•	•	•			•
Suspended "stand on" plastic fender for better splash protection			•		•	•	
Safety cable (for iCatch mechanism)				•		•	
No-maintenance sealed bearing	•	•	•	•	•	•	•
iCatch bow cup				•		•	
Marine jack (optional)	•	•	•	•	•	•	•
Walk pad carpet (optional)	•			•			
Watercraft guiding rails				•		•	
WARRANTY			1/5 YEARS*			1/5 YEARS*	

*One year complete warranty and 5 years on frame and axle.



MARINE JACK
1,200 lb (544 kg) heavy-duty swivel mount caster jack. Corrosion resistant zinc plated finish. Provides 12" (30 cm) of screw travel and up to 27" (69 cm) of lift.
Sea-Doo Move I & II Trailers
295100502 - Galvanized
295100503 - Painted Silver
\$79.99



iCATCH BOW CUP
Adaptor cup for iCatch system replaces standard bow eye on all Sea-Doo watercraft.
Sea-Doo Move I & II iCatch Trailers
295100546
\$54.99



COUPLER STAND
Prevents coupler from hitting the ground when trailer is not hitched to a vehicle. Includes installation hardware.
295100594
\$23.99

WHY I DOO.

Here's what riders like you are saying about BRP Riding Gear & Accessories.

SKI MODULE



"Wakeskating is really technical, so holding a steady speed is crucial. The Ski Mode makes driving really easy and ensures you get a consistent pull every time."
Ben Horan, Wakeskater of the Year

FORCE PULLOVER PFD



"I wore the X-Team PFD as part of the race's approved safety equipment. It's got everything you can ask for in a PFD including a nice snug fit, good padding in the chest and back without the feeling of being overly bulky, solid lanyard hook, race approved safety buckles, and a side entry fit that helps prevent the PFD from coming off when in the water."
Kevin Wassum, Ultimate Sea-Doo Fan, contest winner and rookie racer



XPS SPRAY CLEANER AND POLISH



"I really liked using the XPS spray cleaner and polish. These products kept my race winning RXP-X shining while out front on the track and on the beach."
Chris MacCluggage, Watercraft Racing Hall-of-Fame member and 15X Champion.

XPS LUBE



"Our teams are logging roughly 300 hours on our Test Ride Tour units in four months and they are put in salt water, muddy water, and every type of water. To ensure the engine, electrical and mechanical connections are protected and lubricated during this demanding use, XPS LUBE is invaluable."
Dalton Platt, Sea-Doo Test Ride Tour Technical Specialist



SEA-DOO RIDING BOOTS

"The Bootie has a great fit, lightweight, drains water well and most important, incredible traction!"
Cody Hawkins, Professional Sea-Doo Racer



RETRACTABLE SKI PYLON



"The Sea-Doo Ski Pylon helps make doing tricks so much easier as it helps pull me up during tricks rather than down."
Nick Taylor, NIKE/Sea-Doo Team Rider



SEA-DOO SPEED TIE



"Our event team goes through the docking process up to 300 times a day and the Sea-Doo Speed Tie makes our life so much easier as riders can tie up and stow the rope so fast. People really see the value of the Speed Tie system when we use it all day long."
Ryan Gros, Sea-Doo Test Ride Tour Event Specialist

JOIN THE
**SEA-DOO
COMMUNITY**
Share. Learn. Connect.

Main website: www.sea-doo.com
Facebook: facebook.com/seadoo
Twitter @brpseadoo
Instagram @brpseadoo
Pinterest @brpseadoo

DESTINATION BOUND SEA-DOO LIFE

Owning a Sea-Doo invites exploration, from simply discovering what's around the next river bend to going out and experiencing whole new worlds. Feeling the travel bug? Here are five of our favorite worldwide choices.



BIMINI, BAHAMAS

Every year, hundreds of Sea-Doo enthusiasts take to the Atlantic waters off South Florida en route to Bimini, an island paradise located roughly 80 km east across the Gulf Stream. One reason they make the journey is to enjoy the unbelievably beautiful emerald blue waters of the Bahamas. Another? Well, let's just say there's a certain cachet that comes with telling people you've ridden a Sea-Doo through the Bermuda Triangle...and returned to tell the tale.

We won't kid you: a Gulf Stream crossing is not

for the unprepared. But those up to the challenge, both mentally and physically, will be rewarded with a treasure trove of memories, including the Sapona shipwreck, downed smugglers' planes, and the infamous Bimini Road, an undersea highway with a mysterious past.

Looking for an escort? Check out the annual Bimini Road Rally, an all-inclusive guided tour put on by the same people who plan high-profile Sea-Doo media events.



MUST-HAVE GEAR: SEA-DOO AMPHIBIOUS RIDING GOGGLES

It only takes the spray of that first wave to remind you an ocean crossing can be brutal on the eyes. Protect them with goggles. Unlike sunglasses, they'll stay on your face; like them they offer UV protection to keep the sun's rays at bay.



LAKE HAVASU CITY, ARIZONA

If there is one location worthy of a PWC pilgrimage, it's Lake Havasu, Arizona. Longtime home to the annual International Jet Sports Boating Association World Finals, Havasu is the epicenter of the PWC universe every October as racers and their fans from countries far and wide descend upon its sunny shores to do battle in this picturesque lake on the Colorado River.

Havasu has a unique history. The city was developed by chainsaw magnate Robert McCulloch, who literally purchased the London Bridge and transported it, block by block, from England to Arizona to serve as the city's focal point. Visitors can now visit the bridge above by road, or below by boat, navigating the canal McCulloch had dredged for this very purpose.

The fun, however, shouldn't just be confined to the city limits. Bring your Sea-Doo, or rent one if you have to, and venture north along the Colorado River to the scenic cliffs of Topock Gorge.



MUST-HAVE GEAR: SEA-DOO RASHGUARD

The combination of the desert heat and sun can be brutal. Take a dunk in your Sea-Doo rashguard to enjoy the benefits of evaporative cooling — and SPF 50 UV protection.



We'll spare you the Great White North jokes. Canada would seemingly get more attention from the Ski-Doo crowd than their Sea-Doo counterparts. But those who dismiss the country based on its snowy rep are missing out on some truly beautiful watercraft riding. And perhaps no area epitomizes Canada's watery beauty better than the Okanagan Valley, a picturesque setting located halfway between Vancouver and Calgary.

Home to the massive Okanagan Lake, as well as 200 smaller lakes scattered throughout the region, the Okanagan Valley is found within the Interior Plateau of British Columbia. With the majestic Coast Mountains blocking the flow of moist air from the west, summers are — surprise! — actually warm and dry, the perfect weather for enjoying your Sea-Doo.

Looking for things to do off the water? The area features numerous hiking and biking trails. Those seeking for a more relaxing pursuit will want to plan a visit to one of the countless wineries that occupy the bluffs bordering the lake.



MUST-HAVE GEAR: DELUXE COMBO WETSUIT

Extend your riding season — and fend off any unseasonable chill — with a versatile Deluxe Combo Suit. It offers the warmth and protection of a john, and the added bonus of a jacket should temps get a little too cool.



OKANAGAN VALLEY, CANADA

What could sound more appealing than a visit to Corsica, a beautiful French island located in the middle of the Mediterranean Sea? Formed through volcanic activity, Corsica — literally nicknamed the Isle of Beauty — is the most geographically diverse of the Mediterranean Islands. Its mountainous backdrop offers awe-inspiring views, but it's the island's 1,000 km of Mediterranean coastline that has made it a favorite of beach and watersport lovers.

Highlights of a Sea-Doo focused trip to Corsica include the Cap Corse peninsula and its

quaint coastal fishing villages; the black-pebble beach and medieval village of Nonza on the cape's western coast; Les Calanques de Piana, dramatic red-granite cliffs that tower above the Mediterranean; and the uninhabited Lavezzi Islands, a favorite for snorkeling and diving.

Off the water? Besides the obvious restaurant and nightlife possibilities, you may want to rent a bicycle. Corsica hosted the first three stages of the 2013 Tour de France.



MUST-HAVE GEAR: SPEED TIE

Island hopping involves a lot of docking and the Sea-Doo Speed Tie can be mounted on any modern Sea-Doo model making tying up easy with 7' (2.1 m) of retractable dock line that can be locked at any length both from the helm and the stem.



GOLD COAST, AUSTRALIA

There's a good chance that Australia is on more than its fair share of Sea-Doo enthusiasts' wish lists. After all, there's just something about a continent that's its own big, sun-drenched island, seemingly filled with friendly, laid-back residents.

Though the choices are endless, it's hard to argue against a visit to the iconic Gold Coast. Check out Surfers Paradise, with its combination of beaches and cafes, restaurants, fashion and nightlife; the sophisticated Main Beach to the north; and the

almost European feel of Broadbeach to the south. All offer plenty of possibilities, both on and off the water.

Locals, however, will advise you not to miss the white-sand beaches — and tranquil lagoons — of South Stradbroke Island.

Largely undeveloped, it's a great spot to get away from the hustle and bustle, as well as a favorite spot to camp. Just don't be surprised if a friendly wallaby decides to wander up to the fire; hundreds call the island home.



MUST-HAVE GEAR: SEA-DOO BOOTIES

Traction is essential, whether you're carving a Gold Coast wave or exploring an unfamiliar shoreline. Sea-Doo booties offer traction, ankle support, and feature mesh panels and a perforated sole for quick drainage.

CORSICA, FRANCE





PARTS

“I always use OEM stuff. I’ve never had a problem even after thousands of hours of riding: so I just continue using OEM parts.”
— Jeremy Schandelmayer



5 ESSENTIAL BRP GENUINE PRODUCTS TO ENSURE A PROPER TUNE-UP



MAINTAIN THE LEVEL OF FUN

KEEP YOUR SEA-DOO HEALTHY FOR A LONG LIFE.

Sea-Doo watercraft are engineered to give families a decade of fun on the water. To help ensure the on-water fun is maximized, some off-water care is required. BRP provides a full array of care and maintenance products to ensure your Sea-Doo looks its best and performs at peak levels.

Suggested Off-Season Products

- **XPS FUEL STABILIZER** – Protect against fuel contamination and residue build-up in the fuel system during extended storage.
- **XPS STORAGE OIL** – Protect your internal engine parts from rust and corrosion due to condensation during prolonged periods of non-use.
- **YUASA SMART SHOT AUTOMATIC BATTERY CHARGER** – When your watercraft battery is removed from the unit, keep it connected to ensure maximum charge.

Suggested In-Season Products

- **XPS LUBE** – This multi-purpose lubricant and water dispersion product should be used to prevent rust, corrosion and moisture intrusion.
- **XPS PWC CLEANING AND DETAILING KIT** – Keep your watercraft clean and protected to ensure your gelcoat, vinyl and other surfaces stay looking new.
- **WATERCRAFT COVER** – While not in use, keep your watercraft covered to protect it from the sun and elements.



XPS 4-STROKE SYNTHETIC OIL
293600112, 293600115



IMPELLER



OIL FILTER
420956741



WEAR RING
2670003712



JET PUMP OIL
293600011

MAKE THE RIGHT CHOICE

BRP’s commitment to quality means that every watercraft is engineered to the highest industry leading standards. Nevertheless, a lack of proper maintenance may cause even the best components to fail eventually.

By using original BRP maintenance parts, you are taking care of your investment.

Products available at your authorized participating Sea-Doo Dealers only. Consult your authorized Sea-Doo dealer, a guarantee of excellence in the maintenance of your personal watercraft. Only authorized dealers can offer original BRP, Rotax and 100% Sea-Doo products and parts.



"The Sea-Doo Flush Kit is easy to use, and flushing after rides is part of taking proper care of my watercraft."

— Tommy Bishop-Strahlo



IMPELLER

High performance impeller designed specifically to maximize your Sea-Doo watercraft and boat performance. Ask your authorized Sea-Doo dealer which one fits your vehicle and your use.

	IMPELLER OUTSIDE DIAMETER		PITCH ANGLE	
	MM	IN		
271000470	139.5	5.49	11 - 22	\$354.99
271000920	155.0	6.10	15 - 21	\$354.99
271001024	155.0	6.10	10 - 21	\$354.99
267000199	155.3	6.11	10 - 20	\$354.99
267000201	155.3	6.11	15 - 21	\$354.99
267000119	155.5	6.12	10 - 21	\$354.99
267000527	155.5	6.12	11 - 17	\$364.99
267000431	155.5	6.12	11 - 18	\$354.99
267000115	155.5	6.12	11 - 19	\$354.99
267000283	159.0	6.26	10 - 21	\$364.99
267000507	159.0	6.26	14 - 24	\$354.99
267000408	159.0	6.26	14 - 25	\$364.99
267000504	159.0	6.26	10 - 22	\$364.99
267000563	159.0	6.26	15 - 22	\$364.99
267000350	159.0	6.26	13 - 18	\$364.99



NGK® SPARK PLUGS
BRP dealers carry the full line of premium NGK spark plugs for Sea-Doo watercrafts and boats.

DCP-R8E

707000246

\$5.99

CR8EB

415129403

\$4.49



PISTON KIT

Everything you need in a box. Each piston kit includes: 1 OEM piston and ring, 2 circlips and piston pin.

947 STD	947 STD oversized	947 DI	947 DI oversized
295501101	295501102	295501103	295501104
\$249.99	\$249.99	\$249.99	\$144.99



"It's a better product, there's a lot more around, the parts are more available, easier to work on, more options."

— Jeremy Schandelmayer



295100555

FLUSH KIT

A must to help keep your engine corrosion free and to maximize performance.

Kit includes all necessary components for a hassle-free flush.

Sea-Doo Spark

295100555

\$34.99



295500068

For use on older watercraft that do not yet have a "T" fitting and don't have the threaded water outlet on the ride shoe.

295500068

\$22.49



COUPLER HOSE

For most watercraft and boat models that already have a "T" fitting. Also for watercraft and boat models that use the flush adapter on the ride shoe water outlet.

295500258

\$24.99



FLUSH ADAPTER

For most watercraft and boat models with a threaded water outlet fitting on the ride shoe.

295500473

\$6.99



DRILL PUMP

Safely and easily removes engine oil.

All 4-TEC engines

295100244

\$26.49



BILGE PUMP KIT

Keeps engine compartment dry. Includes 460 gph bilge pump, stainless steel mounting bracket, bilge fitting, hose and hardware necessary for installation.

Sea-Doo Spark

295100497

\$144.99

Models 2010 and up with iBR* and GTS (2011 and up)

295100434

\$149.99

2014 GTI, GTS, GTR, WAKE 155 S

295100597

\$149.99

*Intelligent Brake and Reverse (iBR)



YUASA® BATTERIES

Top of the line models from the preferred original equipment battery supplier in North America.

19 amps. Dry (YB16CL-B)

278001756

\$95.99

30 amps. Dry (YB30CLB)

278001882

\$152.99

30 amps. Wet (BBPM7230L)

515176151

\$177.99



YUASA SMART SHOT AUTOMATIC BATTERY CHARGER

Yuasa Smart Shot automatic battery chargers are available in 900 milliamp and 1.5 amp charge capacities and ensure that optimum power is available from your battery when you need it. Both chargers are supplied with a fused-ring connector, in addition to the alligator clips that can be attached permanently to your battery, making charging and maintaining your battery a snap.

Automatic 6/12V 1.5 amps. 5 Stage

529035772

\$87.99

900 Automatic 12V 900MA

529035773

\$46.99



LIFT KIT

Accurately lift and position your watercraft with a lift kit of nylon webbing and vinyl-coated steel lift plates. Lifting capacity of 1,200 lb (544 kg).

529036189

\$449.99

TOP REASONS WHY YOUR BRP ROTAX ENGINE DESERVES XPS



- Extra engine protection for heavy loads and high RPMs.
- Friction modifiers designed for optimal clutch performance.
- Additional corrosion protection for wet environments and periods of extended non-use.
- All climate synthetic base oils for easy starting.
- Years of extensive R&D and rigorous testing with industry leading Rotax engines.



MAINTENANCE PRODUCTS



XPS SYNTHETIC GREASE
Recommended for marine applications. This synthetic grease provides the best wear protection and water-resistance available.
400 g
293550010
\$25.99



XPS STORAGE OIL
This specialty oil is a must when putting your watercraft away for extended periods. Specially formulated to protect the engine's internal parts from the hazards of rust and corrosion due to condensation during storage or prolonged periods of non-use.
350 g
413711600
\$12.99



XPS LUBE
A multipurpose lubricant that prevents rust, corrosion and moisture intrusion. Contains active extreme-pressure additives that provide excellent lubrication and antiwear properties. Comes in a spray can that works even when turned upside down.
400 g
293600016
\$14.99



XPS 4-STROKE MAINTENANCE AND OIL CHANGE KIT
For all 4-stroke Sea-Doo engines, except Sea-Doo Spark engine. Kit includes: 3.785 L of XPS synthetic oil, oil filter, 3 NGK spark plugs and instruction sheet.
295501075
\$89.99

ENGINE OILS



XPS 4-STROKE SYNTHETIC OIL - ALL CLIMATE GRADE
The same kind of protection our summer grade oil offers, but in the proper formula for colder temperatures. Designed specifically for BRP high output 4-stroke engines, not automobiles or trucks.
946 ml
293600112
3.785 L
293600115



XPS 4-STROKE SYNTHETIC OIL - SUMMER GRADE
Designed specifically for BRP high output 4-stroke engines to protect in the most demanding conditions, when ridden by even the most aggressive riders.
946 ml
293600121
3.785 L
293600122



XPS 2-STROKE SYNTHETIC OIL
The ultimate in protection, this low-ash 2-stroke fully synthetic injection oil was developed specifically for our highest performance engines. Meets the lubrication requirements of Sea-Doo watercraft equipped with Rotax carbureted, RFI or DI 2-stroke engines.
946 ml
293600132
3.785 L
293600133



XPS 2-STROKE SYNTHETIC BLEND OIL
This 2-stroke synthetic blend's new formulation was developed specifically for Sea-Doo watercraft with Rotax RFI and carbureted 2-stroke engines. Extends engine life and reduces smoke emissions and combustion deposits compared to conventional oils.
946 ml
293600100
3.785 L
293600101



XPS 2-STROKE MINERAL OIL
Formulated and developed to work specifically in Sea-Doo watercraft equipped with Rotax carbureted 2-stroke engines.
946 ml
293600117
3.785 L
293600118

CLEANERS



XPS MICROFIBER TOWELS
Made up of extremely fine fibers, their soft surfaces have been perfected for drying and polishing boats, motorcycles, cars or any shiny finish. XPS Microfiber Towels are so absorbent they hold up to seven times their weight in water. Machine washable means they can be used over and over again. Pack of 2.
219701759
\$9.99



XPS FUEL STABILIZER
Fuel additive to protect against fuel contamination and residue build-up in all fuel systems. Should be used before storing your watercraft for any long period of time. Suitable for all gasoline engines.
240 ml
413408601
\$12.99



PRE-MIXED ANTIFREEZE/COOLANT
Pre-mixed, ready to top off your coolant level. Blended for our Rotax engines with anti-corrosive additive.
1 liter
219700362
- 2013 and prior
\$10.99



XPS JET PUMP OIL
Helps maintain the life of your Sea-Doo watercraft jet pump.
170 g
293600011
\$20.99



XPS BOAT & PWC CLEANING AND DETAILING KIT
Everything needed for care and cleaning, including the bucket. Includes: All Purpose Cleaner, Vinyl Cleaner, Spray Cleaner & Polish, 2 microfiber towels, Deluxe Wash Sponge.
219701715
\$64.99
All these products are available individually.

219701709	XPS All Purpose Cleaner • 946 ml	\$9.99
219701710	XPS Vinyl Cleaner • 946 ml	\$14.99
219701706*	XPS Spray Cleaner & Polish • 397 g	\$11.99
219701711	XPS Boat & PWC Wash & Wax • 946 ml	\$11.99

*Not for Sea-Doo Spark.

RIDE IT HARD. TREAT IT RIGHT.



**XPS. THE ONLY OIL ENGINEERED BY BRP
FOR THE LEVEL OF PERFORMANCE YOU EXPECT.**

FOR THE FULL XPS STORY, VISIT XPSLUBRICANTS.COM